

Cleanroom Type

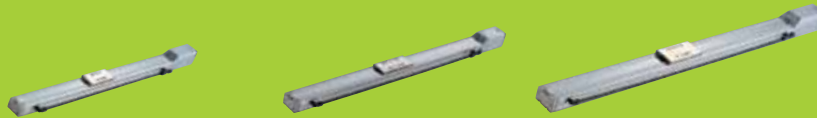

Cleanroom Type

RCP2CR RCACR RCS2CR



RCP2CR-SA5C

RCP2CR-SA6C

RCP2CR-SA7C



RCP2CR-SS7C

RCP2CR-SS8C



RCACR/RCS2CR
-SA4C

RCACR/RCS2CR
-SA5C

RCACR/RCS2CR
-SA5D

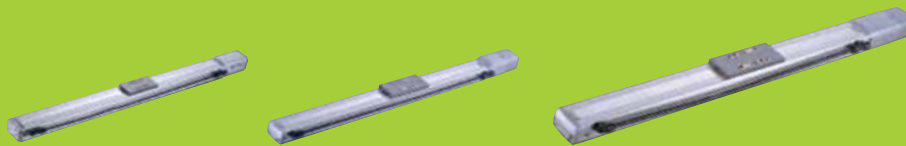

RCS2CR-SA6C

RCS2CR-SS7C

RCS2CR-SS8C

397 Cleanroom Type

Sold & Serviced By:



Toll Free Phone (877) SERV098

Toll Free Fax (877) SERV099

www.electromate.com

sales@electromate.com

RCP2CR <i>series</i> Pulse Motor Type	Slider Coupling Type	Aluminum Base	52mm Width	RCP2CR-SA5C	399		
			58mm Width	RCP2CR-SA6C	401		
			73mm Width	RCP2CR-SA7C	403		
	Slider Coupling Type	Steel Base	60mm Width	RCP2CR-SS7C	405		
			80mm Width	RCP2CR-SS8C	407		
			High-Speed Type	80mm Width	RCP2CR-HS8C	409	
	Gripper Type	Mini Slider Type	42mm Width	RCP2CR-GRSS	411		
		Mini Lever Type	42mm Width	RCP2CR-GRLS	413		
RCACR <i>series</i> 24V Servo Motor Type	Slider Coupling Type	Aluminum Base	40mm Width	RCACR-SA4C	415		
			52mm Width	RCACR-SA5C	417		
			58mm Width	RCACR-SA6C	419		
	Slider Built-In Type	Aluminum Base	52mm Width	RCACR-SA5D	421		
			58mm Width	RCACR-SA6D	423		
RCS2CR <i>series</i> 200V Servo Motor Type	Slider Coupling Type	Aluminum Base	40mm Width	RCS2CR-SA4C	425		
			52mm Width	RCS2CR-SA5C	427		
			58mm Width	RCS2CR-SA6C	429		
			73mm Width	RCS2CR-SA7C	431		
	Slider Coupling Type	Steel Base	60mm Width	RCS2CR-SS7C	433		
			80mm Width	RCS2CR-SS8C	435		
			Slider Built-In Type	Aluminum Base	52mm Width	RCS2CR-SA5D	437
					58mm Width	RCS2CR-SA6D	439

Slider Type

Mini

Standard

Controllers Integrated

Rod Type

Mini

Standard

Controllers Integrated

Table/Arm /Flat Type

Mini

Standard

Gripper/ Rotary Type

Linear Servo Type

Cleanroom Type

Splash-Proof

Controllers

PMEC /AMEC

PSEP /ASEP

ROBO NET

ERC2

PCON

ACON

SCON

PSEL

ASEL

SSEL

XSEL

Pulse Motor

Servo Motor (24V)

Servo Motor (200V)

Linear Servo Motor

RCP2CR-SA5C Cleanroom ROBO Cylinder Slider Coupling Type 52mm Width

Pulse motor Aluminum Base

■ Configuration: **RCP2CR-SA5C-I-42P** - [] - [] - [] - []

Series — Type — Encoder — Motor — Lead — Stroke — Compatible Controllers — Cable Length — Option

I: Incremental 42P: Pulse motor 12: 12mm 50: 50mm
 * The simple absolute encoder is also considered type "I". 42 □ size 6: 6mm 800: 800mm (50mm pitch increments)

P1: PCON N: None BE: Brake (Cable exiting from end)
 RPCON P: 1m BL: Brake (Cable exiting from left)
 PSEL S: 3m BR: Brake (Cable exiting from right)
 P3: PMEC M: 5m NM: Reversed-home
 PSEP X □ □ : Custom VR: Intake port on opposite side
 R □ □ : Robot cable

* See page Pre-35 for an explanation of the naming convention.

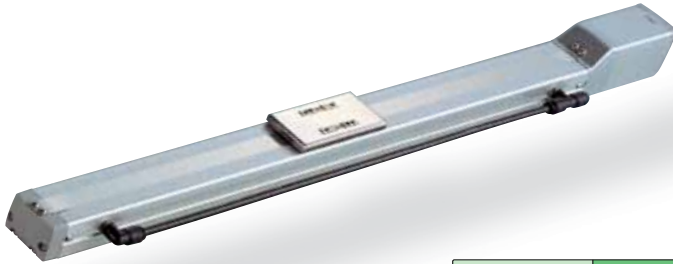

Technical References P. A-5

- Notes on Selection**
- When the stroke increases, the maximum speed will drop to prevent the ball screw from reaching the critical rotational speed. Use the actuator specification table below to check the maximum speed at the stroke you desire.
 - Since the RCP2 series use the pulse motor, the load capacity decreases at high speeds. In the Speed vs. Load Capacity graph on the right, see if your desired speed and load capacity are supported.
 - The load capacity is based on operation at an acceleration of 0.3G (0.2G for the 3mm-lead model, or when used vertically). The maximum acceleration is 0.7G (0.3G when used vertically), however, note that the load capacity decreases at high accelerations. For more information, see the table of load capacity by acceleration, on page A-53.
 - The cleanliness class 10 is for horizontal usage. Please note that the actuator may not support C10 when used on its side or in vertical orientation.

■ **Speed vs. Load Capacity**
 Due to the characteristics of the Pulse motor, the RCP2 series' load capacity decreases at high speeds. In the table below, check if your desired speed and load capacity are supported.

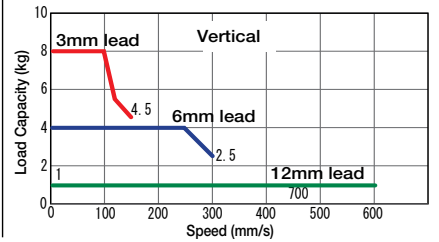
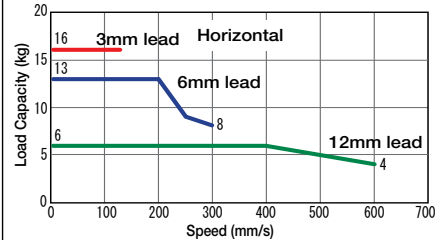

Actuator Specifications

■ **Lead and Load Capacity** (Note 1) Please note that the maximum load capacity decreases as the speed increases.

Model	Lead (mm)	Max. Load Capacity (Note 1)		Stroke (mm)
		Horizontal (kg)	Vertical (kg)	
RCP2CR-SA5C-I-42P-12-①-②-③-④	12	~ 6	1	50 ~ 800 (50mm increments)
RCP2CR-SA5C-I-42P-6-①-②-③-④	6	~ 13	~ 4	
RCP2CR-SA5C-I-42P-3-①-②-③-④	3	16	~ 8	

Legend: ① Stroke ② Compatible controller ③ Cable length ④ Options

■ **Stroke, Max. Speed, and Suction Volume**

Stroke Lead	50 ~ 550 (50mm increments)	600 (mm)	650 (mm)	700 (mm)	750 (mm)	800 (mm)	Suction Volume (Nl/min)
	12	600	540	460	400	360	
6	300	270	230	200	180	150	30
3	150	135	115	100	90	75	15

(Unit: mm/s)

① **Stroke List**

Stroke (mm)	Standard Price
50	-
100	-
150	-
200	-
250	-
300	-
350	-
400	-
450	-
500	-
550	-
600	-
650	-
700	-
750	-
800	-

③ **Cable List**

Type	Cable Symbol	Standard Price
Standard Type	P (1m)	-
	S (3m)	-
	M (5m)	-
Special Lengths	X06 (6m) ~ X10 (10m)	-
	X11 (11m) ~ X15 (15m)	-
	X16 (16m) ~ X20 (20m)	-
	R01 (1m) ~ R03 (3m)	-
Robot Cable	R04 (4m) ~ R05 (5m)	-
	R06 (6m) ~ R10 (10m)	-
	R11 (11m) ~ R15 (15m)	-
	R16 (16m) ~ R20 (20m)	-

* See page A-39 for cables for maintenance.

④ **Option List**

Name	Option Code	See Page	Standard Price
Brake (Cable exiting from end)	BE	→ A-25	-
Brake (Cable exiting from left)	BL	→ A-25	-
Brake (Cable exiting from right)	BR	→ A-25	-
Reversed-home	NM	→ A-33	-
Intake port on opposite side	VR	→ A-38	-

Actuator Specifications

Item	Description
Drive System	Ball screw ø10mm C10 grade
Positioning Repeatability	±0.02mm
Lost Motion	0.1mm or less
Allowable Static Moment	Ma: 18.6N·m Mb: 26.6N·m Mc: 47.5N·m
Allowable Dynamic Moment (*)	Ma: 4.9N·m Mb: 6.8N·m Mc: 11.7N·m
Overhang Load Length	Ma direction: 150mm or less Mb, Mc direction: 150mm or less
Grease Type	Low dust generation grease (both ball screw and guide)
Cleanliness	Class 10 (0.1µm)
Ambient Operating Temp./Humidity	0~40°C, 85% RH or less (non-condensing)

(*) Based on a 5,000km service life.

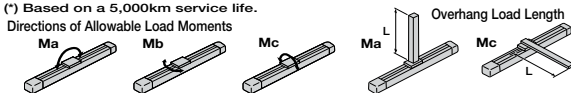

399 RCP2CR-SA5C

Dimensions

For Special Orders P. A-9

- *1 The motor-encoder cable is connected here. See page A-39 for details on cables.
- *2 When homing, the slider moves to the ME; therefore, please watch for any interference with the surrounding objects.
ME: Mechanical end
SE: Stroke end
The values enclosed in "() " are reference dimensions.
- *3 Reference position for calculating the moment Ma

*For the reversed-home model, the dimensions (distance to home) on the motor-side and that on the opposite side are flipped.

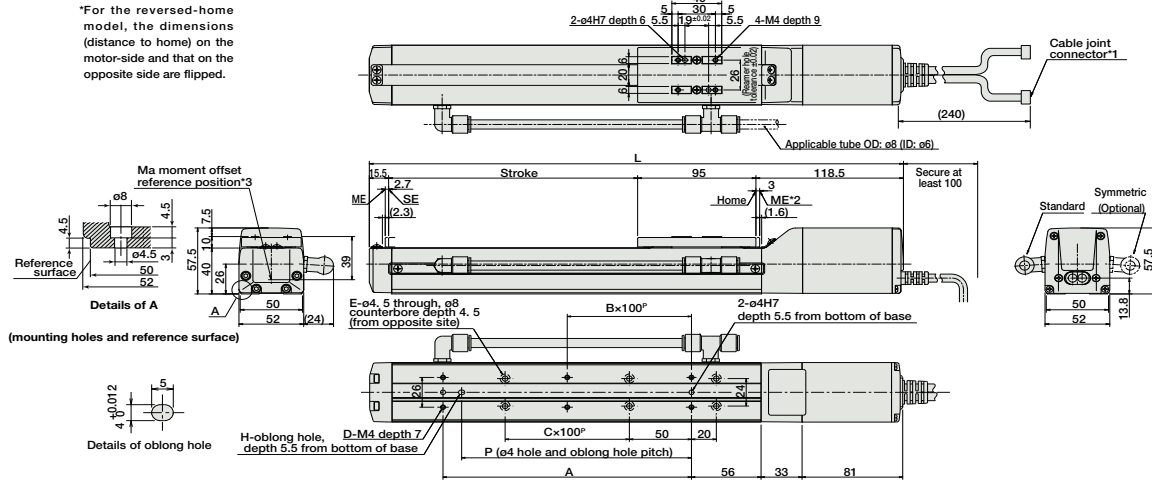

Dimensions of the Brake Section

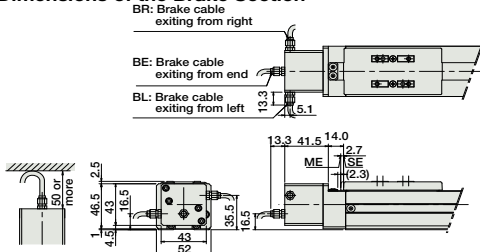

* The length L of a brake-equipped actuator is longer than that of a standard model (see the table) by 40mm (53.3mm with the cable exit out its end); add 0.4kg to weight.

■ Dimensions and Weight by Stroke

Stroke	50	100	150	200	250	300	350	400	450	500	550	600	650	700	750	800
L	279	329	379	429	479	529	579	629	679	729	779	829	879	929	979	1029
A	73	100	100	200	200	300	300	400	400	500	500	600	600	700	700	800
B	0	0	0	1	1	2	2	3	3	4	4	5	5	6	6	7
C	0	0	1	1	2	2	3	3	4	4	5	5	6	6	7	7
D	4	4	4	6	6	8	8	10	10	12	12	14	14	16	16	18
E	4	4	6	6	8	8	10	10	12	12	14	14	16	16	18	18
H	0	1	1	1	1	1	1	1	1	1	1	1	1	1	1	1
P	0	85	85	185	185	285	285	385	385	485	485	585	585	685	685	785
Weight (kg)	1.7	1.8	1.9	2.0	2.1	2.3	2.4	2.5	2.6	2.7	2.8	3.0	3.1	3.2	3.3	3.4

② Compatible Controllers

The RCP2CR series actuators can operate with the controllers below. Select the controller according to your usage.

Name	External View	Model	Description	Max. Positioning Points	Input Voltage	Power Supply Capacity	Standard Price	See Page
Solenoid Valve Type		PMEC-C-42PI-NP-2-(1)	Easy-to-use controller, even for beginners	3 points	AC100V AC200V	See P481	-	→ P477
		PSEP-C-42PI-NP-2-0-H	Operable with same signal as solenoid valve. Supports both single and double solenoid types. No homing necessary with simple absolute type.					→ P487
Splash-Proof Solenoid Valve Type		PSEP-CW-42PI-NP-2-0-H						
Positioner Type		PCON-C-42PI-NP-2-0-H	Positioning is possible for up to 512 points	512 points				
Safety-Compliant Positioner Type		PCON-CG-42PI-NP-2-0-H						
Pulse Train Input Type (Differential Line Driver)		PCON-PL-42PI-NP-2-0-H	Pulse train input type with differential line driver support	(-)	DC24V	2A max.		→ P525
Pulse Train Input Type (Open Collector)		PCON-PO-42PI-NP-2-0-H	Pulse train input type with open collector support					
Serial Communication Type		PCON-SE-42PI-N-0-0-H	Dedicated to serial communication	64 points				
Field Network Type		RPCON-42P-H	Dedicated to field network	768 points				→ P503
Program Control Type		PSEL-C-1-42PI-NP-2-0-H	Programmed operation is possible Operation is possible on up to 2 axes	1500 points				→ P557

* This is for the single-axis PSEL.
* (1) is a placeholder for the power supply voltage (1: 100V, 2: 100~240V).

- Slider Type
- Mini
- Standard
- Controllers Integrated
- Rod Type
- Mini
- Standard
- Controllers Integrated
- Table/Arm /Flat Type
- Mini
- Standard
- Gripper/ Rotary Type
- Linear Servo Type
- Cleanroom Type
- Splash-Proof
- Controllers
- PMEC /AMEC
- PSEP /ASEP
- ROBO NET
- ERC2
- PCON
- ACON
- SCON
- PSEL
- ASEL
- SSEL
- XSEL
- Pulse Motor
- Servo Motor (24V)
- Servo Motor (200V)
- Linear Servo Motor

RCP2CR-SA6C

Cleanroom ROBO Cylinder Slider Coupling Type 58mm Width Pulse motor
Aluminum Base

■ Configuration: **RCP2CR-SA6C-I-42P** — [] — [] — [] — [] — []

Series — Type — Encoder — Motor — Lead — Stroke — Compatible Controllers — Cable Length — Option

I: Incremental
* The simple absolute encoder is also considered type "I".

42P: Pulse motor 42 size

12: 12mm
6: 6mm
3: 3mm

50: 50mm
800: 800mm (50mm pitch increments)

P1: PCON
RPNON
PSEL
P3: PMEC
PSEP

N: None
P: 1m
S: 3m
M: 5m
X []: Custom
R []: Robot cable

BE: Brake (Cable exiting from end)
BL: Brake (Cable exiting from left)
BR: Brake (Cable exiting from right)
NM: Reversed-home
VR: Intake port on opposite side

* See page Pre-35 for an explanation of the naming convention.

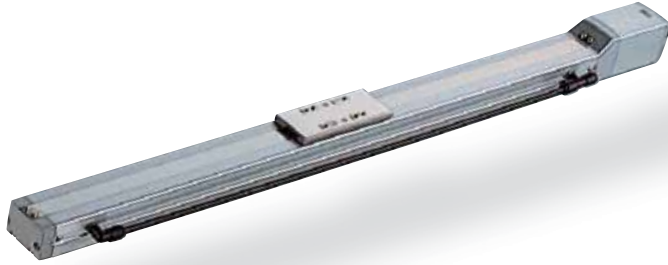

Technical References P. A-5

- POINT** Notes on Selection
- When the stroke increases, the maximum speed will drop to prevent the ball screw from reaching the critical rotational speed. Use the actuator specification table below to check the maximum speed at the stroke you desire.
 - Since the RCP2 series use the pulse motor, the load capacity decreases at high speeds. In the Speed vs. Load Capacity graph on the right, see if your desired speed and load capacity are supported.
 - The load capacity is based on operation at an acceleration of 0.3G (0.2G for the 3mm-lead model, or when used vertically). The maximum acceleration is 0.7G (0.3G when used vertically), however, note that the load capacity decreases at high accelerations. For more information, see the table of load capacity by acceleration, on page A-53.
 - The cleanliness class 10 is for horizontal usage. Please note that the actuator may not support C10 when used on its side or in vertical orientation.

■ Speed vs. Load Capacity
Due to the characteristics of the Pulse motor, the RCP2 series' load capacity decreases at high speeds. In the table below, check if your desired speed and load capacity are supported.

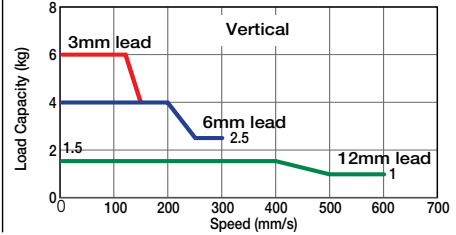
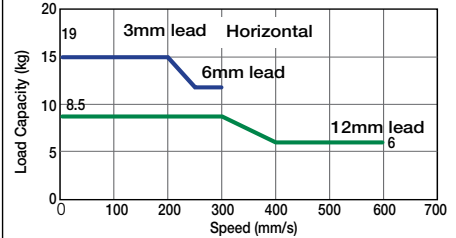

Actuator Specifications

(Note 1) Please note that the maximum load capacity decreases as the speed increases.

Model	Lead (mm)	Max. Load Capacity (Note 1)		Stroke (mm)
		Horizontal (kg)	Vertical (kg)	
RCP2CR-SA6C-I-42P-12-①-②-③-④	12	~ 8.5	~ 1.5	50 ~ 800 (50mm increments)
RCP2CR-SA6C-I-42P-6-①-②-③-④	6	~ 15	~ 4	
RCP2CR-SA6C-I-42P-3-①-②-③-④	3	~ 19	~ 6	

Legend: ① Stroke ② Compatible controller ③ Cable length ④ Options

■ Stroke, Max. Speed, and Suction Volume

Stroke (mm)	Max. Speed (mm/s)						Suction Volume (Nl/min)
	50 ~ 550 (50mm increments)	600	650	700	750	800	
12	600	540	460	400	360	300	50
6	300	270	230	200	180	150	30
3	150	135	115	100	90	75	15

(Unit: mm/s)

① Stroke List

Stroke (mm)	Standard Price
50	-
100	-
150	-
200	-
250	-
300	-
350	-
400	-
450	-
500	-
550	-
600	-
650	-
700	-
750	-
800	-

③ Cable List

Type	Cable Symbol	Standard Price
Standard Type	P (1m)	-
	S (3m)	-
	M (5m)	-
Special Lengths	X06 (6m) ~ X10 (10m)	-
	X11 (11m) ~ X15 (15m)	-
	X16 (16m) ~ X20 (20m)	-
	R01 (1m) ~ R03 (3m)	-
Robot Cable	R04 (4m) ~ R05 (5m)	-
	R06 (6m) ~ R10 (10m)	-
	R11 (11m) ~ R15 (15m)	-
	R16 (16m) ~ R20 (20m)	-

* See page A-39 for cables for maintenance.

④ Option List

Name	Option Code	See Page	Standard Price
Brake (Cable exiting from end)	BE	→ A-25	-
Brake (Cable exiting from left)	BL	→ A-25	-
Brake (Cable exiting from right)	BR	→ A-25	-
Reversed-home	NM	→ A-33	-
Intake port on opposite side	VR	→ A-38	-

Actuator Specifications

Item	Description
Drive System	Ball screw ø10mm C10 grade
Positioning Repeatability	±0.02mm
Lost Motion	0.1mm or less
Allowable Static Moment	Ma: 38.3N·m Mb: 54.7N·m Mc: 81.0N·m
Allowable Dynamic Moment (*)	Ma: 8.9N·m Mb: 12.7N·m Mc: 18.6N·m
Overhang Load Length	Ma direction: 220mm or less Mb, Mc direction: 220mm or less
Grease Type	Low dust generation grease (both ball screw and guide)
Cleanliness	Class 10 (0.1µm)
Ambient Operating Temp./Humidity	0 ~ 40°C, 85% RH or less (non-condensing)

(*) Based on a 5,000km service life.

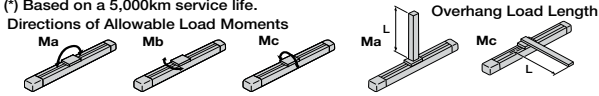

401 RCP2CR-SA6C

Dimensions

For Special Orders P. A-9

- *1 The motor-encoder cable is connected here. See page A-39 for details on cables.
- *2 When homing, the slider moves to the ME; therefore, please watch for any interference with the surrounding objects.
ME: Mechanical end
SE: Stroke end
- *3 Reference position for calculating the moment M_a .
The values enclosed in "()" are reference dimensions.

*For the reversed-home model, the dimensions (distance to home) on the motor-side and that on the opposite side are flipped.

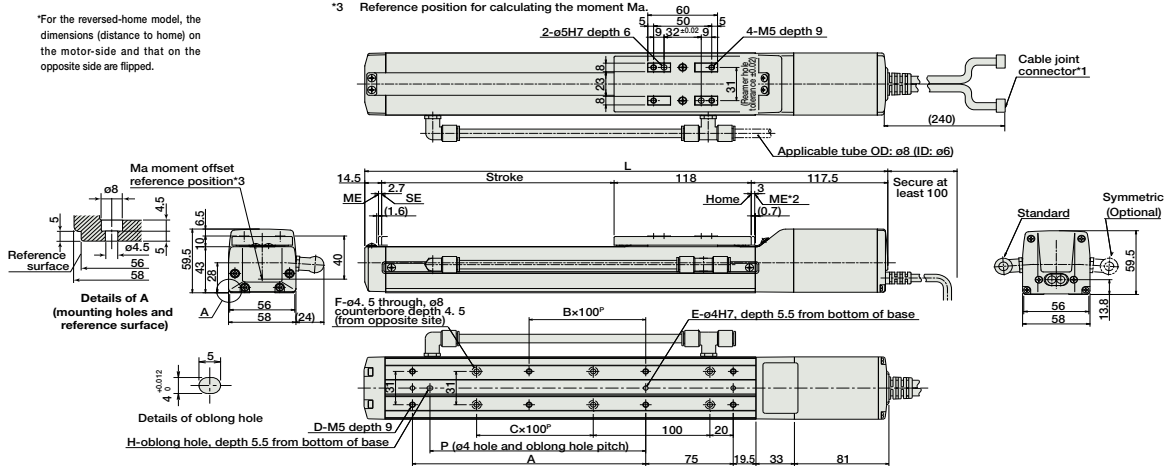

Dimensions of the Brake Section

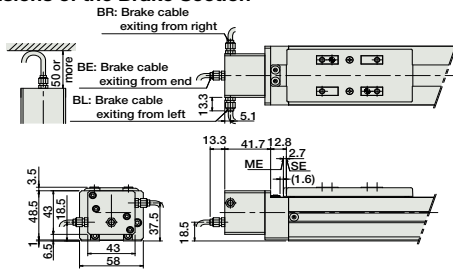

* The length L of a brake-equipped actuator is longer than that of a standard model (see the table) by 40mm (53.3mm with the cable exit out its end); add 0.4kg to weight.

■ Dimensions and Weight by Stroke

Stroke	50	100	150	200	250	300	350	400	450	500	550	600	650	700	750	800
L	300	350	400	450	500	550	600	650	700	750	800	850	900	950	1000	1050
A	0	100	100	200	200	300	300	400	400	500	500	600	600	700	700	800
B	0	0	0	1	1	2	2	3	3	4	4	5	5	6	6	7
C	0	0	1	1	2	2	3	3	4	4	5	5	6	6	7	7
D	4	6	6	8	8	10	10	12	12	14	14	16	16	18	18	20
E	2	3	3	3	3	3	3	3	3	3	3	3	3	3	3	3
F	4	4	6	6	8	8	10	10	12	12	14	14	16	16	18	18
H	0	1	1	1	1	1	1	1	1	1	1	1	1	1	1	1
P	0	85	85	185	185	285	285	385	385	485	485	585	585	685	685	785
Weight (kg)	2.0	2.2	2.3	2.4	2.6	2.7	2.9	3.0	3.1	3.3	3.4	3.6	3.7	3.8	4.0	4.1

② Compatible Controllers

The RCP2CR series actuators can operate with the controllers below. Select the controller according to your usage.

Name	External View	Model	Description	Max. Positioning Points	Input Voltage	Power Supply Capacity	Standard Price	See Page
Solenoid Valve Type		PMEC-C-42PI-NP-2-①	Easy-to-use controller, even for beginners	3 points	AC100V AC200V	See P481	-	→ P477
		PSEP-C-42PI-NP-2-0-H	Operable with same signal as solenoid valve. Supports both single and double solenoid types. No homing necessary with simple absolute type.					→ P487
Splash-Proof Solenoid Valve Type		PSEP-CW-42PI-NP-2-0-H						
Positioner Type		PCON-C-42PI-NP-2-0-H	Positioning is possible for up to 512 points	512 points				
Safety-Compliant Positioner Type		PCON-CG-42PI-NP-2-0-H						
Pulse Train Input Type (Differential Line Driver)		PCON-PL-42PI-NP-2-0-H	Pulse train input type with differential line driver support	(-)	DC24V	2A max.		→ P625
Pulse Train Input Type (Open Collector)		PCON-PO-42PI-NP-2-0-H	Pulse train input type with open collector support					
Serial Communication Type		PCON-SE-42PI-N-0-0-H	Dedicated to serial communication	64 points				
Field Network Type		RPCON-42P-H	Dedicated to field network	768 points				→ P503
Program Control Type		PSEL-C-1-42PI-NP-2-0-H	Programmed operation is possible Operation is possible on up to 2 axes	1500 points				→ P557

* This is for the single-axis PSEL.
* ① is a placeholder for the power supply voltage (1: 100V, 2: 100~240V).

- Slider Type
- Mini
- Standard
- Controllers Integrated
- Rod Type
- Mini
- Standard
- Controllers Integrated
- Table/Arm /Flat Type
- Mini
- Standard
- Gripper/ Rotary Type
- Linear Servo Type
- Cleanroom Type
- Splash-Proof
- Controllers
- PMEC /AMEC
- PSEP /ASEP
- ROBO NET
- ERC2
- PCON
- ACON
- SCON
- PSEL
- ASEL
- SSEL
- XSEL
- Pulse Motor
- Servo Motor (24V)
- Servo Motor (200V)
- Linear Servo Motor

RCP2CR-SA7C

Cleanroom ROBO Cylinder Slider Coupling Type 73mm Width Pulse motor
Aluminum Base

■ Configuration: **RCP2CR** — **SA7C** — **I** — **56P** — — — — —

Series — Type — Encoder — Motor — Lead — Stroke — Compatible Controllers — Cable Length — Option

I: Incremental
* The simple absolute encoder is also considered type "I".

56P: Pulse motor
56 □ size

16: 16mm
8: 8mm
4: 4mm

50: 50mm
800: 800mm (50mm pitch increments)

P1: PCON
RPCON
PSEL
P3: PMEC
PSEP

N: None
P: 1m
S: 3m
M: 5m
X □ □: Custom
R □ □: Robot cable

BE: Brake (Cable exiting from end)
BL: Brake (Cable exiting from left)
BR: Brake (Cable exiting from right)
NM: Reversed-home

* See page Pre-35 for an explanation of the naming convention.

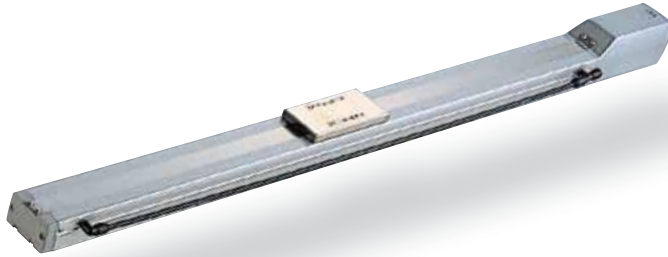

Technical References P. A-5

- POINT** Notes on Selection
- When the stroke increases, the maximum speed will drop to prevent the ball screw from reaching the critical rotational speed. Use the actuator specification table below to check the maximum speed at the stroke you desire.
 - Since the RCP2 series use the pulse motor, the load capacity decreases at high speeds. In the Speed vs. Load Capacity graph on the right, see if your desired speed and load capacity are supported.
 - The load capacity is based on operation at an acceleration of 0.3G (0.2G for the 4mm-lead model, or when used vertically). This is the upper limit of the acceleration.
 - The cleanliness class 10 is for horizontal usage. Please note that the actuator may not support C10 when used on its side or in vertical orientation.

■ Speed vs. Load Capacity
Due to the characteristics of the Pulse motor, the RCP2 series' load capacity decreases at high speeds. In the table below, check if your desired speed and load capacity are supported.

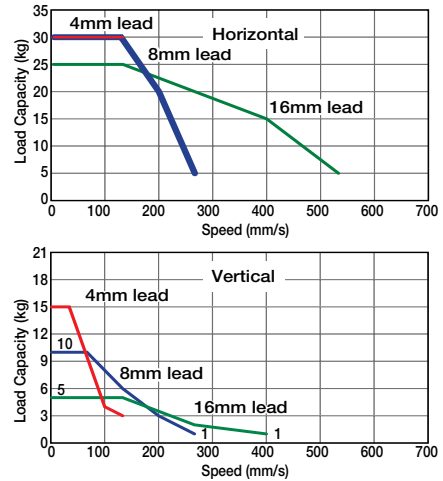

Actuator Specifications

■ Lead and Load Capacity (Note 1) Please note that the maximum load capacity decreases as the speed increases.

Model	Lead (mm)	Max. Load Capacity (Note 1)		Stroke (mm)
		Horizontal (kg)	Vertical (kg)	
RCP2CR-SA7C-I-56P-16-①-②-③-④	16	~ 25	~ 5	50~800 (50mm increments)
RCP2CR-SA7C-I-56P-8-①-②-③-④	8	~ 30	~ 10	
RCP2CR-SA7C-I-56P-4-①-②-③-④	4	~ 30	~ 15	

Legend: ① Stroke ② Compatible controller ③ Cable length ④ Options

■ Stroke, Max. Speed, and Suction Volume

Lead	Stroke	50 ~ 700 (50mm increments)		~ 800 (mm)	Suction Volume (Nl/min)
		500	<400>	<400>	
16	16	533	<400>	480	70
8	8	266		240	40
4	4	133		120	30

* The values enclosed in "< >" apply to vertical usage (Unit: mm/s)

① Stroke List

Stroke (mm)	Standard Price
50/100	-
150/200	-
250/300	-
350/400	-
450/500	-
550/600	-
650/700	-
750/800	-

③ Cable List

Type	Cable Symbol	Standard Price
Standard Type	P (1m)	-
	S (3m)	-
	M (5m)	-
Special Lengths	X06 (6m) ~ X10 (10m)	-
	X11 (11m) ~ X15 (15m)	-
	X16 (16m) ~ X20 (20m)	-
	R01 (1m) ~ R03 (3m)	-
Robot Cable	R04 (4m) ~ R05 (5m)	-
	R06 (6m) ~ R10 (10m)	-
	R11 (11m) ~ R15 (15m)	-
	R16 (16m) ~ R20 (20m)	-

* See page A-39 for cables for maintenance.

④ Option List

Name	Option Code	See Page	Standard Price
Brake (Cable exiting from end)	BE	→ A-25	-
Brake (Cable exiting from left)	BL	→ A-25	-
Brake (Cable exiting from right)	BR	→ A-25	-
Reversed-home	NM	→ A-33	-
Intake port on opposite side	VR	→ A-38	-

Actuator Specifications

Item	Description
Drive System	Ball screw ø12mm C10 grade
Positioning Repeatability	±0.02mm
Lost Motion	0.1mm or less
Allowable Static Moment	Ma: 50.4N·m Mb: 71.9N·m Mc: 138.0N·m
Allowable Dynamic Moment (*)	Ma: 13.9N·m Mb: 19.9N·m Mc: 38.3N·m
Overhang Load Length	Ma direction: 230mm or less Mb, Mc direction: 230mm or less
Grease Type	Low dust generation grease (both ball screw and guide)
Cleanliness	Class 10 (0.1µm)
Ambient Operating Temp./Humidity	0~40°C, 85% RH or less (non-condensing)

(*) Based on a 5,000km service life.

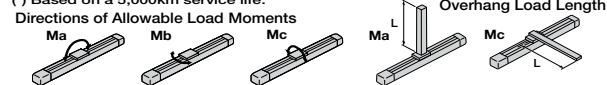

403 RCP2CR-SA7C

RCP2CR-SS7C

Cleanroom ROBO Cylinder Slider Coupling Type 60mm Width Pulse motor Steel Base

■ Configuration: **RCP2CR-SS7C-I-42P** - [] - [] - [] - [] - []

Series — Type — Encoder — Motor — Lead — Stroke — Compatible Controllers — Cable Length — Option

I: Incremental
* The simple absolute encoder is also considered type "I".

42P: Pulse motor 42 size

12: 12mm
6: 6mm
3: 3mm

50: 50mm
600: 600mm (50mm pitch increments)

P1: PCON
RPCON
PSEL
P3: PMEC
PSEP

N: None
P: 1m
S: 3m
M: 5m
X []: Custom
R []: Robot cable

B: Brake
NM: Reversed-home
VR: Intake port on opposite side

* See page Pre-35 for an explanation of the naming convention.

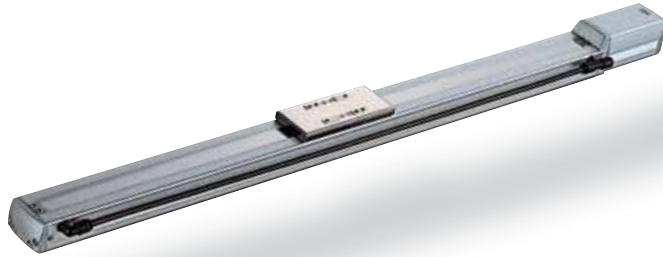

Technical References P. A-5

POINT Notes on Selection

- When the stroke increases, the maximum speed will drop to prevent the ball screw from reaching the critical rotational speed. Use the actuator specification table below to check the maximum speed at the stroke you desire.
- Since the RCP2 series use the pulse motor, the load capacity decreases at high speeds. In the Speed vs. Load Capacity graph on the right, see if your desired speed and load capacity are supported.
- The load capacity is based on operation at an acceleration of 0.3G (0.2G for the 3mm-lead model, or when used vertically). This is the upper limit of the acceleration.

■ Speed vs. Load Capacity
Due to the characteristics of the Pulse motor, the RCP2 series' load capacity decreases at high speeds. In the table below, check if your desired speed and load capacity are supported.

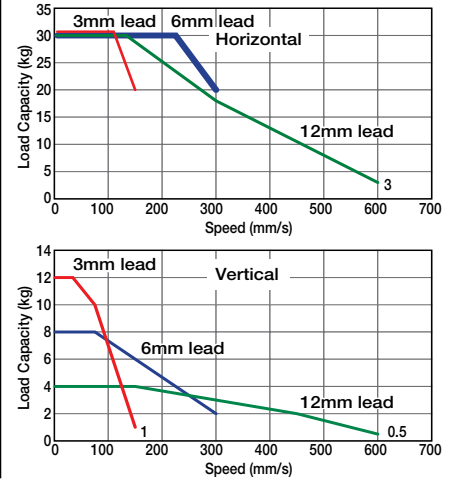

Actuator Specifications

■ Lead and Load Capacity (Note 1) Please note that the maximum load capacity decreases as the speed increases.

Model	Lead (mm)	Max. Load Capacity (Note 1)		Stroke (mm)
		Horizontal (kg)	Vertical (kg)	
RCP2CR-SS7C-I-42P-12-①-②-③-④	12	~ 30	~ 4	50~600 (50mm increments)
RCP2CR-SS7C-I-42P-6-①-②-③-④	6	~ 30	~ 8	
RCP2CR-SS7C-I-42P-3-①-②-③-④	3	~ 30	~ 12	

Legend: ① Stroke ② Compatible controller ③ Cable length ④ Options

■ Stroke, Max. Speed, and Suction Volume

Lead	Stroke		Suction Volume (Nl/min)
	50 ~ 500 (50mm increments)	~ 600 (mm)	
12	600	470	50
6	300	230	30
3	150	115	15

(Unit: mm/s)

① Stroke List

Stroke (mm)	Standard Price
50/100	-
150/200	-
250/300	-
350/400	-
450/500	-
550/600	-

③ Cable List

Type	Cable Symbol	Standard Price
Standard Type	P (1m)	-
	S (3m)	-
	M (5m)	-
Special Lengths	X06 (6m) ~ X10 (10m)	-
	X11 (11m) ~ X15 (15m)	-
	X16 (16m) ~ X20 (20m)	-
	R01 (1m) ~ R03 (3m)	-
Robot Cable	R04 (4m) ~ R05 (5m)	-
	R06 (6m) ~ R10 (10m)	-
	R11 (11m) ~ R15 (15m)	-
	R16 (16m) ~ R20 (20m)	-

* See page A-39 for cables for maintenance.

④ Option List

Name	Option Code	See Page	Standard Price
Brake	B	→ A-25	-
Reversed-home	NM	→ A-33	-
Intake port on opposite side	VR	→ A-38	-

Actuator Specifications

Item	Description
Drive System	Ball screw ø10mm C10 grade
Positioning Repeatability	±0.02mm
Lost Motion	0.05mm or less
Allowable Static Moment	Ma: 79.4N·m Mb: 79.4N·m Mc: 172.9N·m
Allowable Dynamic Moment (*)	Ma: 14.7N·m Mb: 14.7N·m Mc: 33.3N·m
Overhang Load Length	Ma direction: 300mm or less Mb, Mc direction: 300mm or less
Grease Type	Low dust generation grease (both ball screw and guide)
Cleanliness	Class 10 (0.1µm)
Ambient Operating Temp./Humidity	0~40°C, 85% RH or less (non-condensing)

(*) Based on a 10,000km service life.

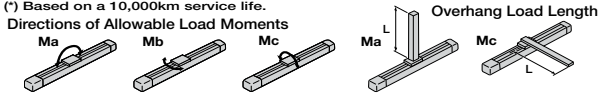

405 RCP2CR-SS7C

- Slider Type
- Mini
- Standard
- Controllers Integrated
- Rod Type
- Mini
- Standard
- Controllers Integrated
- Table/Arm/Flat Type
- Mini
- Standard
- Gripper/Rotary Type
- Linear Servo Type
- Cleanroom Type
- Splash-Proof
- Controllers
- PMEC/AMEC
- PSEP/ASEP
- ROBO NET
- ERC2
- PCON
- ACON
- SCON
- PSEL
- ASEL
- SSEL
- XSEL
- Pulse Motor
- Servo Motor (24V)
- Servo Motor (200V)
- Linear Servo Motor

Dimensions

For Special Orders P. A-9

- *1 The motor-encoder cable is connected here. See page A-39 for details on cables.
- *2 When homing, the slider moves to the ME; therefore, please watch for any interference with the surrounding objects.
ME: Mechanical end
SE: Stroke end
The dimensions enclosed in "()" are reference dimensions.
- *3 Reference position for calculating the moment Ma.

*For the reversed-home model, the dimensions (distance to home) on the motor-side and that on the opposite side are flipped.

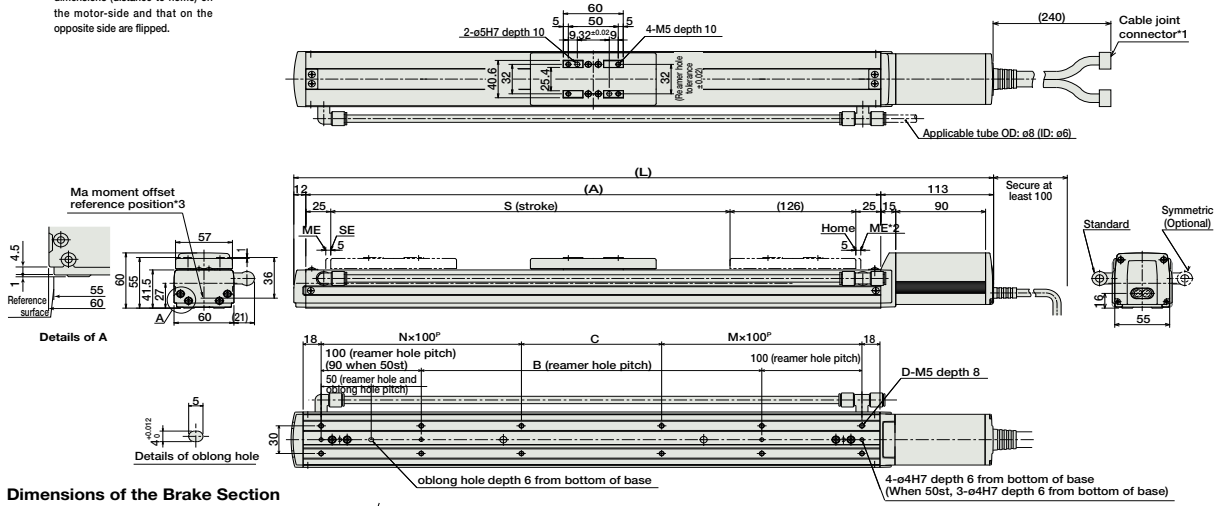

Dimensions of the Brake Section

The length L of a brake-equipped actuator is longer than that of a standard model (see the table) by 24.5mm; add 0.3kg to weight.

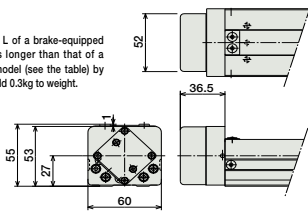

■ Dimensions and Weight by Stroke

Stroke	50	100	150	200	250	300	350	400	450	500	550	600
L	351	401	451	501	551	601	651	701	751	801	851	901
A	226	276	326	376	426	476	526	576	626	676	726	776
B	0	40	90	140	190	240	290	340	390	440	490	540
C	90	40	90	140	190	40	90	140	190	40	90	140
D	6	8	8	8	8	12	12	12	12	16	16	16
M	1	1	1	1	1	2	2	2	2	3	3	3
N	0	1	1	1	1	2	2	2	2	3	3	3
Weight (kg)	3.3	3.6	3.9	4.2	4.6	4.9	5.3	5.6	6.0	6.3	6.6	6.9

② Compatible Controllers

The RCP2CR series actuators can operate with the controllers below. Select the controller according to your usage.

Name	External View	Model	Description	Max. Positioning Points	Input Voltage	Power Supply Capacity	Standard Price	See Page
Solenoid Valve Type		PMEC-C-42PI-NP-2-①	Easy-to-use controller, even for beginners	3 points	AC100V AC200V	See P481	-	→ P477
		PSEP-C-42PI-NP-2-0	Operable with same signal as solenoid valve. Supports both single and double solenoid types. No homing necessary with simple absolute type.					→ P487
Splash-Proof Solenoid Valve Type		PSEP-CW-42PI-NP-2-0						
Positioner Type		PCON-C-42PI-NP-2-0	Positioning is possible for up to 512 points	512 points	DC24V	2A max.	-	→ P525
Safety-Compliant Positioner Type		PCON-CG-42PI-NP-2-0						
Pulse Train Input Type (Differential Line Driver)		PCON-PL-42PI-NP-2-0	Pulse train input type with differential line driver support	(-)	DC24V	2A max.	-	→ P525
Pulse Train Input Type (Open Collector)		PCON-PO-42PI-NP-2-0	Pulse train input type with open collector support					
Serial Communication Type		PCON-SE-42PI-N-0-0	Dedicated to serial communication	64 points				
Field Network Type		RPCON-42P	Dedicated to field network	768 points				→ P503
Program Control Type		PSEL-C-1-42PI-NP-2-0	Programmed operation is possible. Operation is possible on up to 2 axes	1500 points				→ P557

* This is for the single-axis PSEL.
* ① is a placeholder for the power supply voltage (1: 100V, 2: 100~240V).

- Slider Type
- Mini
- Standard
- Controllers Integrated
- Rod Type
- Mini
- Standard
- Controllers Integrated
- Table/Arm /Flat Type
- Mini
- Standard
- Gripper/ Rotary Type
- Linear Servo Type
- Cleanroom Type
- Splash-Proof
- Controllers
- PMEC /AMEC
- PSEP /ASEP
- ROBO NET
- ERC2
- PCON
- ACON
- SCON
- PSEL
- ASEL
- SSEL
- XSEL
- Pulse Motor
- Servo Motor (24V)
- Servo Motor (200V)
- Linear Servo Motor

RCP2CR-SS8C

Cleanroom ROBO Cylinder Slider Coupling Type 80mm Width Pulse motor
Steel Base

■ Configuration: **RCP2CR-SS8C-I-56P**

Series	Type	Encoder	Motor	Lead	Stroke	Compatible Controllers	Cable Length	Option
I: Incremental * The simple absolute encoder is also considered type "I"	56P: Pulse motor 56 □ size	20:20mm 10:10mm 5: 5mm	50: 50mm 1000: 1000mm (50mm pitch increments)	P1: PCON RPCON PSEL P3: PMEC PSEP	N : None P : 1m S : 3m M : 5m X □ : Custom R □ : Robot cable	B : Brake NM : Reversed-home VR : Intake port on opposite side		

* See page Pre-35 for an explanation of the naming convention.

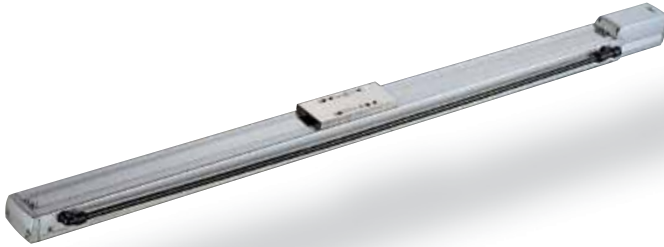

Technical References P. A-5

POINT Notes on Selection

- When the stroke increases, the maximum speed will drop to prevent the ball screw from reaching the critical rotational speed. Use the actuator specification table below to check the maximum speed at the stroke you desire.
- Since the RCP2 series use the pulse motor, the load capacity decreases at high speeds. In the Speed vs. Load Capacity graph on the right, see if your desired speed and load capacity are supported.
- The load capacity is based on operation at an acceleration of 0.3G (0.2G for the 5mm-lead model, or when used vertically). This is the upper limit of the acceleration.

■ Speed vs. Load Capacity
Due to the characteristics of the Pulse motor, the RCP2 series' load capacity decreases at high speeds. In the table below, check if your desired speed and load capacity are supported.

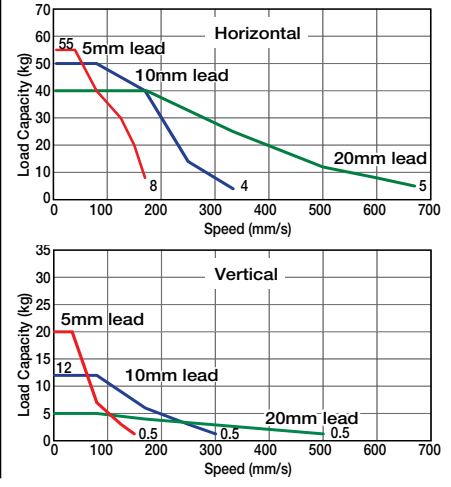

Actuator Specifications

■ Lead and Load Capacity (Note 1) Please note that the maximum load capacity decreases as the speed increases.

Model	Lead (mm)	Max. Load Capacity (Note 1)		Stroke (mm)
		Horizontal (kg)	Vertical (kg)	
RCP2CR-SS8C-I-56P-20-①-②-③-④	20	~ 40	~ 5	50 ~ 1000 (50mm increments)
RCP2CR-SS8C-I-56P-10-①-②-③-④	10	~ 50	~ 12	
RCP2CR-SS8C-I-56P-5-①-②-③-④	5	~ 55	~ 20	

Legend: ① Stroke ② Compatible controller ③ Cable length ④ Options

■ Stroke, Max. Speed, and Suction Volume

Stroke / Lead	50 ~ 800 (50mm increments)		~ 900 (mm)	~ 1000 (mm)	Suction Volume (N/min)
	Max. Speed (mm/s)	Max. Load Capacity (kg)	Max. Speed (mm/s)	Max. Load Capacity (kg)	
20	666 <500>	625 <500>	515 <500>	80	
10	333 <300>	310 <300>	255	40	
5	165 <150>	155 <150>	125	20	

* The values enclosed in "<" apply to vertical usage (Unit: mm/s)

① Stroke List

Stroke (mm)	Standard Price
50/100	-
150/200	-
250/300	-
350/400	-
450/500	-
550/600	-
650/700	-
750/800	-
850/900	-
950/1000	-

③ Cable List

Type	Cable Symbol	Standard Price
Standard Type	P (1m)	-
	S (3m)	-
	M (5m)	-
Special Lengths	X06 (6m) ~ X10 (10m)	-
	X11 (11m) ~ X15 (15m)	-
	X16 (16m) ~ X20 (20m)	-
	R01 (1m) ~ R03 (3m)	-
Robot Cable	R04 (4m) ~ R05 (5m)	-
	R06 (6m) ~ R10 (10m)	-
	R11 (11m) ~ R15 (15m)	-
	R16 (16m) ~ R20 (20m)	-

* See page A-39 for cables for maintenance.

④ Option List

Name	Option Code	See Page	Standard Price
Brake	B	→ A-25	-
Reversed-home	NM	→ A-33	-
Intake port on opposite side	VR	→ A-38	-

Actuator Specifications

Item	Description
Drive System	Ball screw ø16mm C10 grade
Positioning Repeatability	±0.02mm
Lost Motion	0.05mm or less
Allowable Static Moment	Ma: 198.9N·m Mb: 198.9N·m Mc: 416.7N·m
Allowable Dynamic Moment (*)	Ma: 36.3N·m Mb: 36.3N·m Mc: 77.4N·m
Overhang Load Length	Ma direction: 450mm or less Mb, Mc direction: 450mm or less
Grease Type	Low dust generation grease (both ball screw and guide)
Cleanliness	Class 10 (0.1µm)
Ambient Operating Temp./Humidity	0~40°C, 85% RH or less (non-condensing)

(*) Based on a 10,000km service life.

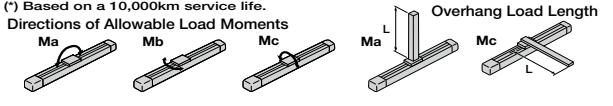

407 RCP2CR-SS8C

Dimensions

For Special Orders P. A-9

- *1 The motor-encoder cable is connected here. See page A-39 for details on cables.
- *2 When homing, the slider moves to the ME; therefore, please watch for any interference with the surrounding objects.
ME: Mechanical end
SE: Stroke end
- *3 Reference position for calculating the moment Ma.

*For the reversed-home model, the dimensions (distance to home) on the motor-side and that on the opposite side are flipped.

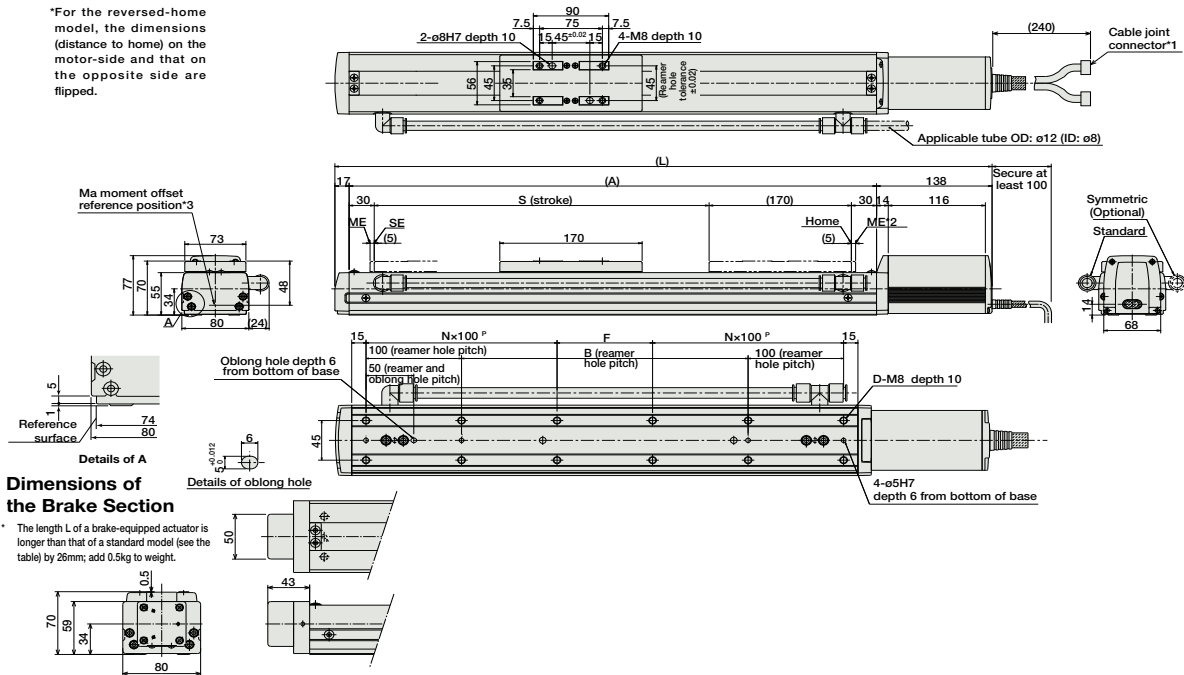

Dimensions of the Brake Section

The length L of a brake-equipped actuator is longer than that of a standard model (see the table) by 26mm; add 0.5kg to weight.

■ Dimensions and Weight by Stroke

Stroke	50	100	150	200	250	300	350	400	450	500	550	600	650	700	750	800	850	900	950	1000
L	435	495	535	585	635	685	735	785	835	885	935	985	1035	1085	1135	1185	1235	1285	1335	1385
A	280	330	380	430	480	530	580	630	680	730	780	830	880	930	980	1030	1080	1130	1180	1230
B	50	100	150	200	250	300	350	400	450	500	550	600	650	700	750	800	850	900	950	1000
D	8	8	8	10	12	12	12	14	16	16	18	20	20	20	22	24	24	24	24	26
F	50	100	150	0	50	100	150	0	50	100	150	0	50	100	150	0	50	100	150	0
N	1	1	1	2	2	2	3	3	3	3	4	4	4	4	5	5	5	5	5	6
Weight (kg)	7.0	7.5	8.0	8.5	9.0	9.6	10.1	10.6	11.2	11.7	12.3	12.7	13.3	13.8	14.4	14.9	15.4	15.9	16.5	17.0

② Compatible Controllers

The RCP2CR series actuators can operate with the controllers below. Select the controller according to your usage.

Name	External View	Model	Description	Max. Positioning Points	Input Voltage	Power Supply Capacity	Standard Price	See Page
Solenoid Valve Type		PMEC-C-56PI-NP-2-①	Easy-to-use controller, even for beginners	3 points	AC100V AC200V	See P481	-	→ P477
		PSEP-C-56PI-NP-2-0	Operable with same signal as solenoid valve. Supports both single and double solenoid types. No homing necessary with simple absolute type.					→ P487
Splash-Proof Solenoid Valve Type		PSEP-CW-56PI-NP-2-0						
Positioner Type		PCON-C-56PI-NP-2-0	Positioning is possible for up to 512 points	512 points				
Safety-Compliant Positioner Type		PCON-CG-56PI-NP-2-0						
Pulse Train Input Type (Differential Line Driver)		PCON-PL-56PI-NP-2-0	Pulse train input type with differential line driver support	(-)	DC24V	2A max.		→ P625
Pulse Train Input Type (Open Collector)		PCON-PO-56PI-NP-2-0	Pulse train input type with open collector support					
Serial Communication Type		PCON-SE-56PI-N-0-0	Dedicated to serial communication	64 points				
Field Network Type		RPCON-56P	Dedicated to field network	768 points				→ P503
Program Control Type		PSEL-C-1-56PI-NP-2-0	Programmed operation is possible. Operation is possible on up to 2 axes	1500 points				→ P557

* This is for the single-axis PSEL.
* ① is a placeholder for the power supply voltage (1: 100V, 2: 100~240V).

- Slider Type
- Mini
- Standard
- Controllers Integrated
- Rod Type
- Mini
- Standard
- Controllers Integrated
- Table/Arm /Flat Type
- Mini
- Standard
- Gripper/ Rotary Type
- Linear Servo Type
- Cleanroom Type
- Splash-Proof
- Controllers
- PMEC /AMEC
- PSEP /ASEP
- ROBO NET
- ERC2
- PCON
- ACON
- SCON
- PSEL
- ASEL
- SSEL
- XSEL
- Pulse Motor
- Servo Motor (24V)
- Servo Motor (200V)
- Linear Servo Motor

RCP2CR-HS8C

Cleanroom ROBO Cylinder High-Speed Slider Coupling Type 80mm Width Pulse motor Steel Base

■ Configuration: **RCP2CR** — **HS8C** — **I** — **86P** — — — **P2** — —

Series — Type — Encoder — Motor — Lead — Stroke — Compatible Controllers — Cable Length — Option

I: Incremental 86P: Pulse motor 56 high output 30: 30mm 50: 50mm 1000: 1000mm (50mm pitch increments) P2: PCON-CF N: None B: Brake
 P: 1m S: 3m M: 5m X : Custom R : Robot cable NM: Reversed-home VR: Intake port on opposite side

* See page Pre-35 for an explanation of the naming convention.

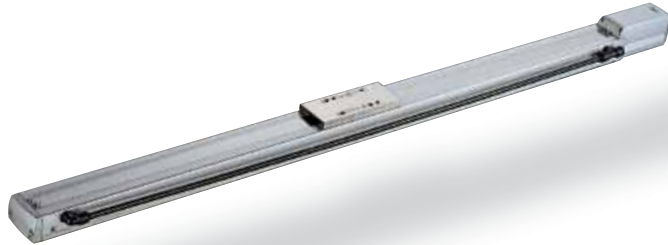

Technical References P. A-5

- POINT** Notes on Selection
- (1) Due to the large lead of the ball screw in high-speed actuators, operating at low speeds may cause vibration and/or noise. Therefore, use the actuator at speeds over 100mm/s.
 - (2) When the stroke increases, the maximum speed will drop to prevent the ball screw from reaching the critical rotational speed. Use the actuator specification table below to check the maximum speed at the stroke you desire.
 - (3) Since the RCP2 series use the pulse motor, the load capacity decreases at high speeds. In the Speed vs. Load Capacity graph on the right, see if your desired speed and load capacity are supported.
 - (4) The load capacity is based on operation at an acceleration of 0.3G (0.2G when used vertically). 0.5G (horizontal) and 0.3G (vertical) are the upper limits of the acceleration.

■ Speed vs. Load Capacity
 Due to the characteristics of the Pulse motor, the RCP2 series' load capacity decreases at high speeds. In the table below, check if your desired speed and load capacity are supported.

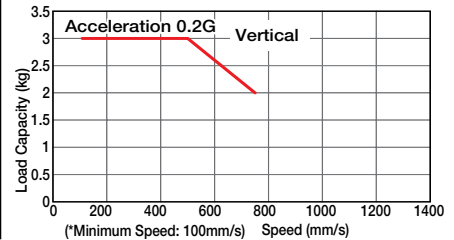
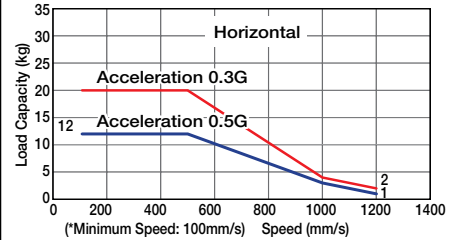

Actuator Specifications				
Lead and Load Capacity		(Note 1) Please note that the maximum load capacity decreases as the speed increases.		
Model	Lead (mm)	Max. Load Capacity (Note 1)		Stroke (mm)
		Horizontal (kg)	Vertical (kg)	
RCP2CR-HS8C-I-86P-30-①-P2-②-③	30	~ 20	~ 3	50~1000 (50mm increments)
Legend ① Stroke ② Cable length ③ Options				
Stroke and Maximum Speed		Suction Volume (N/min)		
Stroke	Lead	50 ~ 800 (50mm increments)	~ 900 (mm)	~ 1000 (mm)
		1200 <math><^*></math> <math><^*></math>	1000 <math><^*></math> <math><^*></math>	800 <math><^*></math> <math><^*></math>
* The values enclosed in * <math><^*></math> apply to vertical usage (Unit: mm/s)				

① Stroke List

Stroke (mm)	Standard Price
50/100	-
150/200	-
250/300	-
350/400	-
450/500	-
550/600	-
650/700	-
750/800	-
850/900	-
950/1000	-

② Cable List

Type	Cable Symbol	Standard Price
Standard Type	P (1m)	-
	S (3m)	-
	M (5m)	-
Special Lengths	X06 (6m) ~ X10 (10m)	-
	X11 (11m) ~ X15 (15m)	-
	X16 (16m) ~ X20 (20m)	-
	R01 (1m) ~ R03 (3m)	-
Robot Cable	R04 (4m) ~ R05 (5m)	-
	R06 (6m) ~ R10 (10m)	-
	R11 (11m) ~ R15 (15m)	-
	R16 (16m) ~ R20 (20m)	-

③ Option List

Name	Option Code	See Page	Standard Price
Brake	B	→ A-25	-
Reversed-home	NM	→ A-33	-
Intake port on opposite side	VR	→ A-38	-

Actuator Specifications

Item	Description
Drive System	Ball screw ϕ 16mm C10 grade
Positioning Repeatability	\pm 0.02mm
Lost Motion	0.05mm or less
Allowable Static Moment	Ma: 198.9N·m Mb: 198.9N·m Mc: 416.7N·m
Allowable Dynamic Moment (*)	Ma: 36.3N·m Mb: 36.3N·m Mc: 77.4N·m
Overhang Load Length	Ma direction: 450mm or less Mb, Mc direction: 450mm or less
Grease Type	Low dust generation grease (both ball screw and guide)
Cleanliness	Class 10 (0.1 μ m)
Ambient Operating Temp./Humidity	0~40°C, 85% RH or less (non-condensing)

(*) Based on a 10,000km service life.

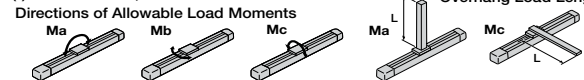

409 RCP2CR-HS8C

Dimensions

For Special Orders P. A-9

- *1 The motor-encoder cable is connected here. See page A-39 for details on cables.
- *2 When homing, the slider moves to the ME; therefore, please watch for any interference with the surrounding objects.
ME: Mechanical end
SE: Stroke end
- *3 Reference position for calculating the moment Ma.

*For the reversed-home model, the dimensions (distance to home) on the motor-side and that on the opposite side are flipped.

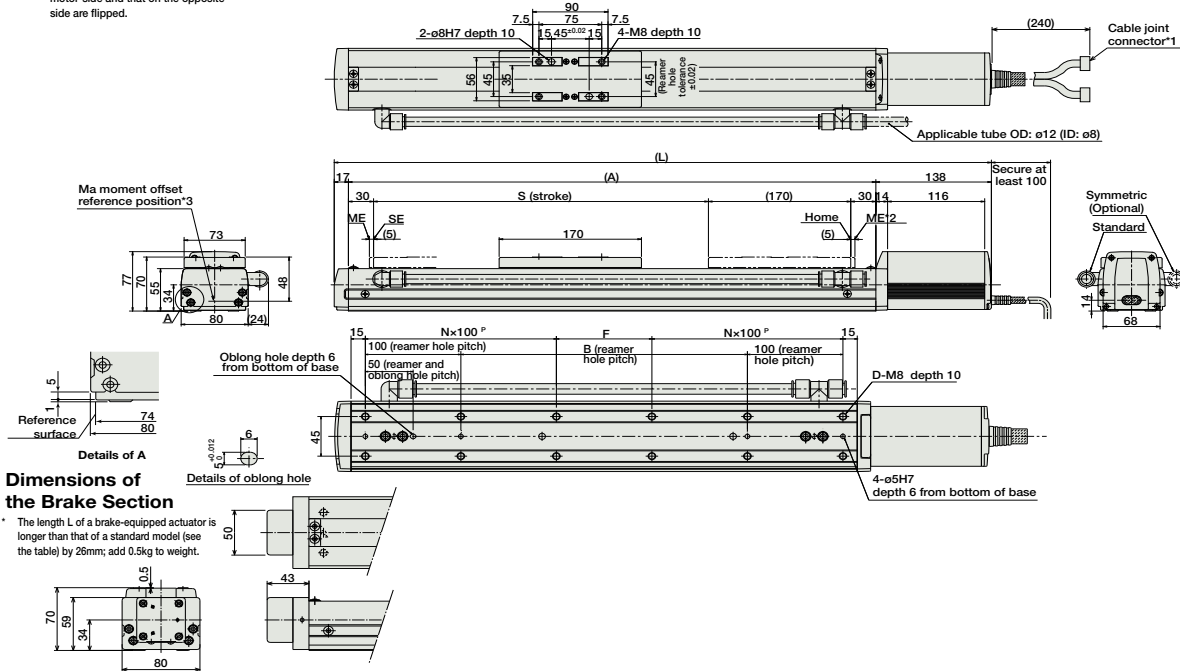

Dimensions and Weight by Stroke

Stroke	50	100	150	200	250	300	350	400	450	500	550	600	650	700	750	800	850	900	950	1000
L	435	485	535	585	635	685	735	785	835	885	935	985	1035	1085	1135	1185	1235	1285	1335	1385
A	280	330	380	430	480	530	580	630	680	730	780	830	880	930	980	1030	1080	1130	1180	1230
B	50	100	150	200	250	300	350	400	450	500	550	600	650	700	750	800	850	900	950	1000
D	8	8	8	10	12	12	12	14	16	16	16	18	20	20	20	22	24	24	24	26
F	50	100	150	0	50	100	150	0	50	100	150	0	50	100	150	0	50	100	150	0
N	1	1	1	2	2	2	3	3	3	3	3	4	4	4	4	5	5	5	5	6
Weight (kg)	7.0	7.5	8.0	8.5	9.0	9.6	10.1	10.6	11.2	11.7	12.3	12.7	13.3	13.8	14.4	14.9	15.4	15.9	16.5	17.0

Compatible Controllers

The RCP2CR-HS8C series actuators can operate with the controllers below.

Name	External View	Model	Description	Max. Positioning Points	Input Voltage	Power Supply Capacity	Standard Price	See Page
Positioner Type		PCON-CF-86PI-NP-2-0	Positioning is possible for up to 512 points	512 points	DC24V	6A max.	-	→ P525

Note: Please note that a dedicated CF type encoder cable is used, which is different from the encoder cable used for the PCON-C/CG/CY/PL/PO/SE controllers.

- Slider Type
- Mini
- Standard
- Controllers Integrated
- Rod Type
- Mini
- Standard
- Controllers Integrated
- Table/Arm /Flat Type
- Mini
- Standard
- Gripper/ Rotary Type
- Linear Servo Type
- Cleanroom Type
- Splash-Proof
- Controllers
- PMEC /AMEC
- PSEP /ASEP
- ROBO NET
- ERC2
- PCON
- ACON
- SCON
- PSEL
- ASEL
- SSEL
- XSEL
- Pulse Motor
- Servo Motor (24V)
- Servo Motor (200V)
- Linear Servo Motor

RCP2CR-GRSS

Cleanroom ROBO Cylinder 2-Finger Gripper Mini Slider Type 42mm Width Pulse motor

■ Configuration: **RCP2CR** - **GRSS** - **I** - **20P** - **30** - **8** - - -

Series — Type — Encoder — Motor — Deceleration Ratio — Stroke — Compatible Controllers — Cable Length — Option

I: Incremental * The simple absolute encoder is also considered type "I".
 20P: Pulse motor 20 □ size
 30 : 1/30 deceleration ratio
 8: 8mm (4mm per side)
 P1: PCON
 RPCON
 PSEL
 P3: PMEC
 PSEP
 N : None
 P : 1m
 S : 3m
 M : 5m
 X □ □ : Custom
 NM: Reversed-home
 FB: Flange bracket
 SB: Shaft bracket

* See page Pre-35 for an explanation of the naming convention.

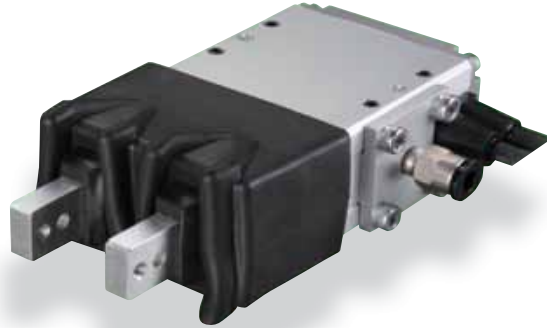

Technical References P. A-5

- POINT** Notes on Selection
- (1) The maximum opening/closing speed indicates the operating speed on one side. The relative operating speed is twice this value.
 - (2) The maximum gripping force is the sum of the gripping forces of both fingers, at a gripping point distance of 0mm and no overhang distance. The workpiece weight that can be actually moved depends on the friction coefficient between the gripper fingers and the workpiece, as well as on the shape of the workpiece. As a rough guide, a workpiece's weight should not exceed 1/10 to 1/20 of the gripping force. (See page A-74 for details.)
 - (3) The rated acceleration while moving is 0.3G.

■ Gripping Force Adjustment
 The gripping (pushing) force can be adjusted freely within the range of current limits of 20% to 70%.

* The gripping forces in the following diagrams indicate the sum of the gripping forces of both fingers.

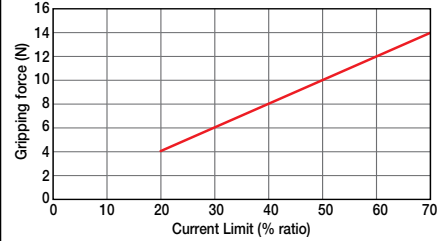

* Please note that, when gripping (pushing), the speed is fixed at 5mm/s.

Actuator Specifications

Lead and Load Capacity

Model	Deceleration Ratio	Max. Gripping Force (N)	Stroke (mm)
RCP2CR-GRSS-I-20P-30-8-①-②-③	30	14	8 (4 per side)

Legend: ① Compatible controllers ② Cable length ③ Options

Stroke, Max. Opening/Closing Speed, and Suction Volume

Deceleration Ratio	Stroke	Suction Volume (Nl/min)
	8 (mm)	
30	78	10

(Unit: mm/s)

Stroke List

Stroke (mm)	Standard Price
8	-

② Cable List

Type	Cable Symbol	Standard Price
Standard Type (Robot Cables)	P (1m)	-
	S (3m)	-
	M (5m)	-
Special Lengths	X06 (6m) ~ X10 (10m)	-
	X11 (11m) ~ X15 (15m)	-
	X16 (16m) ~ X20 (20m)	-
		-

* The standard cable is the motor-encoder integrated robot cable.

* See page A-39 for cables for maintenance.

③ Option List

Name	Option Code	See Page	Standard Price
Reversed-home	NM	→ A-33	-
Flange bracket	FB	→ A-26	-
Shaft bracket	SB	→ A-36	-

Actuator Specifications

Item	Description
Drive System	Worm gear + helical gear + helical rack
Positioning Repeatability	±0.01mm
Backlash	0.2mm or less per side (constantly pressed out by a spring)
Lost Motion	0.05mm or less per side
Guide	Linear guide
Allowable Static Load Moment	Ma: 0.5N·m Mb: 0.5N·m Mc: 1.5N·m
Weight	0.2kg
Cleanliness	Class 10 (0.1µm)
Ambient Operating Temp./Humidity	0~40°C, 85% RH or less (non-condensing)

411 RCP2CR-GRSS

- Slider Type
- Mini
- Standard
- Controllers Integrated
- Rod Type
- Mini
- Standard
- Controllers Integrated
- Table/Arm/Flat Type
- Mini
- Standard
- Gripper/Rotary Type
- Linear Servo Type
- Cleanroom Type
- Splash-Proof
- Controllers
- PMEC/AMEC
- PSEP/ASEP
- ROBO NET
- ERC2
- PCON
- ACON
- SCON
- PSEL
- ASEL
- SSEL
- XSEL
- Pulse Motor
- Servo Motor (24V)
- Servo Motor (200V)
- Linear Servo Motor

Dimensions

For Special Orders P. A-9

* The opening side of the slider is the home position.
 * 1 The motor-encoder cable is connected here. See page A-39 for details on cables.

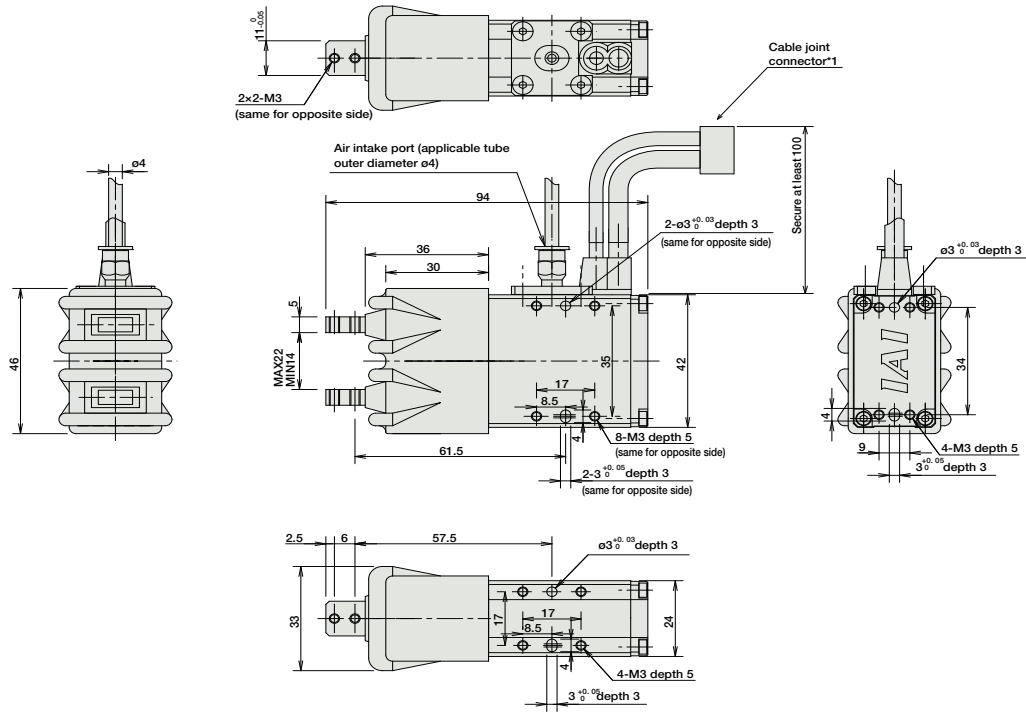

Weight (kg) 0.2

① Compatible Controllers

The RCP2CR series actuators can operate with the controllers below. Select the controller according to your usage.

Name	External View	Model	Description	Max. Positioning Points	Input Voltage	Power Supply Capacity	Standard Price	See Page
Solenoid Valve Type		PMEC-C-20PI-NP-2-①	Easy-to-use controller, even for beginners	3 points	AC100V AC200V	See P481	-	→ P477
		PSEP-C-20PI-NP-2-0	Operable with same signal as solenoid valve. Supports both single and double solenoid types. No homing necessary with simple absolute type.					→ P487
Splash-Proof Solenoid Valve Type		PSEP-CW-20PI-NP-2-0					-	
Positioner Type		PCON-C-20PI-NP-2-0	Positioning is possible for up to 512 points	512 points			-	
Safety-Compliant Positioner Type		PCON-CG-20PI-NP-2-0						
Pulse Train Input Type (Differential Line Driver)		PCON-PL-20PI-NP-2-0	Pulse train input type with differential line driver support	(-)	DC24V	2A max.	-	→ P525
Pulse Train Input Type (Open Collector)		PCON-PO-20PI-NP-2-0	Pulse train input type with open collector support					
Serial Communication Type		PCON-SE-20PI-N-0-0	Dedicated to serial communication	64 points			-	
Field Network Type		RPCON-20P	Dedicated to field network	768 points			-	→ P503
Program Control Type		PSEL-C-1-20PI-NP-2-0	Programmed operation is possible Operation is possible on up to 2 axes	1500 points			-	→ P557

* This is for the single-axis PSEL.
 * ① is a placeholder for the power supply voltage (1: 100V, 2: 100~240V).

IAI

RCP2CR-GRSS **412**

- Slider Type
- Mini
- Standard
- Controllers Integrated
- Rod Type
- Mini
- Standard
- Controllers Integrated
- Table/Arm /Flat Type
- Mini
- Standard
- Gripper/ Rotary Type
- Linear Servo Type
- Cleanroom Type
- Splash-Proof
- Controllers
- PMEC /AMEC
- PSEP /ASEP
- ROBO NET
- ERC2
- PCON
- ACON
- SCON
- PSEL
- ASEL
- SSEL
- XSEL
- Pulse Motor
- Servo Motor (24V)
- Servo Motor (200V)
- Linear Servo Motor

RCP2CR-GRLS

Cleanroom ROBO Cylinder 2-Finger Gripper Mini Lever Type 42mm Width
Pulse motor

■ Configuration: **RCP2CR** — **GRLS** — **I** — **20P** — **30** — **180** — — —

Series — Type — Encoder — Motor — Deceleration Ratio — Stroke — Compatible Controllers — Cable Length — Option

I: Incremental
* The simple absolute encoder is also considered type "I".

20P: Pulse motor
20 size

30: 1/30
deceleration ratio

180: 180 degrees
(90 degrees per side)

P1: PCON
RPCON
PSEL
P3: PMEC
PSEP

N: None
P: 1m
S: 3m
M: 5m
X : Custom

NM: Reversed-home
FB: Flange bracket
SB: Shaft bracket

* See page Pre-35 for an explanation of the naming convention.



Technical References P. A-5

- POINT**
Notes on Selection
- (1) The maximum opening/closing speed indicates the operating speed on one side. The relative operating speed is twice this value.
 - (2) The maximum gripping force is the sum of the gripping forces of both fingers, at a gripping point distance of 0mm and no overhanging distance. The workpiece weight that can be actually moved depends on the friction coefficient between the gripper fingers and the workpiece, as well as on the shape of the workpiece. As a rough guide, a workpiece's weight should not exceed 1/10 to 1/20 of the gripping force. (See page A-77 for details.)
 - (3) The rated acceleration while moving is 0.3G.

■ **Gripping Force Adjustment**
The gripping (pushing) force can be adjusted freely within the range of current limits of 20% to 70%.

* The gripping forces in the following diagrams indicate the sum of the gripping forces of both fingers.

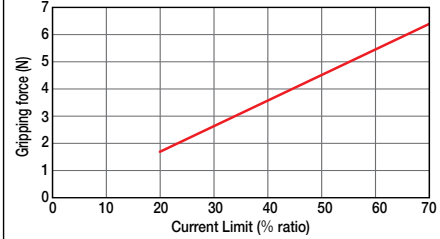

* Please note that, when gripping (pushing), the speed is fixed at 5 degrees/s.

Actuator Specifications

■ Lead and Load Capacity

Model	Deceleration Ratio	Max. Gripping Force (N)	Stroke (deg)
RCP2CR-GRLS-I-20P-30-180-①-②-③	30	6.4	180 (90 per side)

Legend: ① Compatible controllers ② Cable length ③ Options

■ Stroke and Maxi. Opening/Closing Speed

Deceleration Ratio	Stroke	180 (deg)
	30	600

(Unit: degrees/s)

① Stroke List

Stroke (deg)	Standard Price
180	—

② Cable List

Type	Cable Symbol	Standard Price
Standard Type (Robot Cables)	P (1m)	—
	S (3m)	—
	M (5m)	—
Special Lengths	X06 (6m) ~ X10 (10m)	—
	X11 (11m) ~ X15 (15m)	—
	X16 (16m) ~ X20 (20m)	—

* The standard cable is the motor-encoder integrated robot cable.

* See page A-39 for cables for maintenance.

③ Option List

Name	Option Code	See Page	Standard Price
Reversed-home	NM	→ A-33	—
Flange bracket	FB	→ A-26	—
Shaft bracket	SB	→ A-36	—

Actuator Specifications

Item	Description
Drive System	Worm gear + helical gear
Positioning Repeatability	±0.01mm
Backlash	1 degree or less per side (constantly pressed out by a spring)
Lost Motion	0.1 degree or less per side
Guide	—
Allowable Static Load Moment	—
Weight	0.2kg
Ambient Operating Temp./Humidity	0~40°C, 85% RH or less (non-condensing)

413

RCP2CR-GRLS

- Slider Type
- Mini
- Standard
- Controllers Integrated
- Rod Type
- Mini
- Standard
- Controllers Integrated
- Table/Arm/Flat Type
- Mini
- Standard
- Gripper/Rotary Type
- Linear Servo Type
- Cleanroom Type
- Splash-Proof
- Controllers
- PMEC/AMEC
- PSEP/ASEP
- ROBO NET
- ERC2
- PCON
- ACON
- SCON
- PSEL
- ASEL
- SSEL
- XSEL
- Pulse Motor
- Servo Motor (24V)
- Servo Motor (200V)
- Linear Servo Motor

Dimensions

For Special Orders P. A-9

* The opening side of the slider is the home position.
 *1 The motor-encoder cable is connected here. See page A-39 for details on cables.

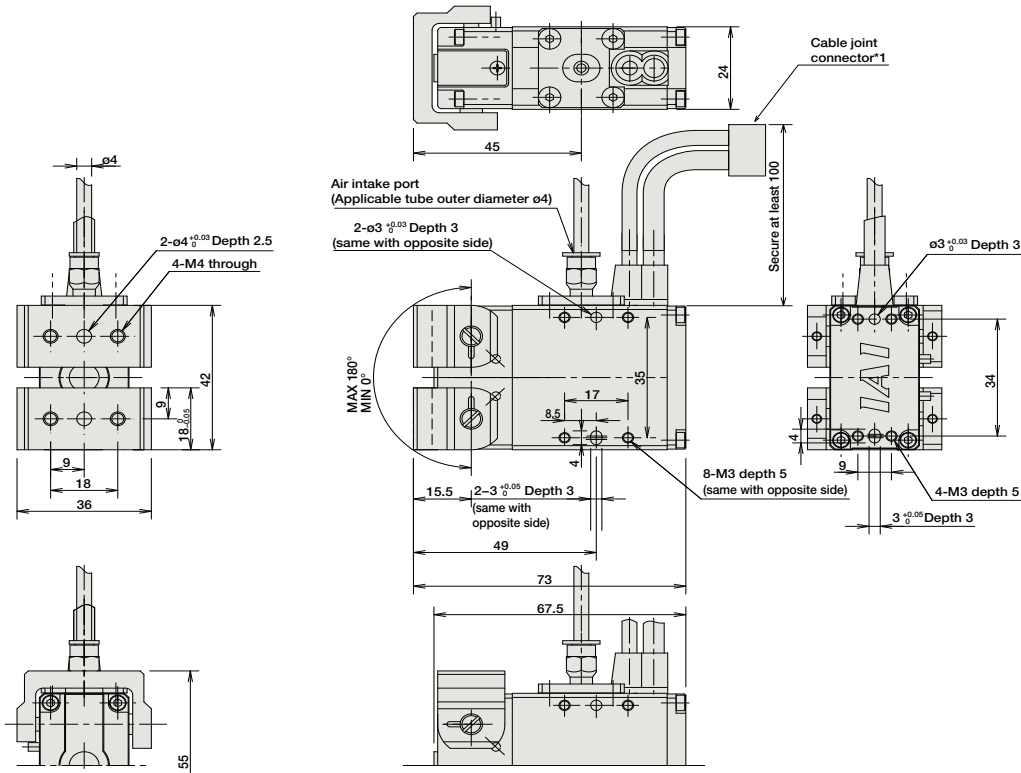

Weight (kg) 0.2

① Compatible Controllers

The RCP2CR series actuators can operate with the controllers below. Select the controller according to your usage.

Name	External View	Model	Description	Max. Positioning Points	Input Voltage	Power Supply Capacity	Standard Price	See Page
Solenoid Valve Type		PMEC-C-20PI-NP-2-①	Easy-to-use controller, even for beginners	3 points	AC100V AC200V	See P481	-	→ P477
Splash-Proof Solenoid Valve Type		PSEP-C-20PI-NP-2-0	Operable with same signal as solenoid valve. Supports both single and double solenoid types. No homing necessary with simple absolute type.					→ P487
Positioner Type		PCON-C-20PI-NP-2-0	Positioning is possible for up to 512 points	512 points	DC24V	2A max.	-	→ P525
Safety-Compliant Positioner Type		PCON-CG-20PI-NP-2-0						
Pulse Train Input Type (Differential Line Driver)		PCON-PL-20PI-NP-2-0	Pulse train input type with differential line driver support	(-)	DC24V	2A max.	-	→ P525
Pulse Train Input Type (Open Collector)		PCON-PO-20PI-NP-2-0	Pulse train input type with open collector support					
Serial Communication Type		PCON-SE-20PI-N-0-0	Dedicated to serial communication	64 points			-	
Field Network Type		RPCON-20P	Dedicated to field network	768 points			-	→ P503
Program Control Type		PSEL-C-1-20PI-NP-2-0	Programmed operation is possible Operation is possible on up to 2 axes	1500 points			-	→ P557

* This is for the single-axis PSEL.
 * ① is a placeholder for the power supply voltage (1: 100V, 2: 100~240V).



RCP2CR-GRLS **414**

- Slider Type
- Mini
- Standard
- Controllers Integrated
- Rod Type
- Mini
- Standard
- Controllers Integrated
- Table/Arm /Flat Type
- Mini
- Standard
- Gripper/ Rotary Type
- Linear Servo Type
- Cleanroom Type
- Splash-Proof
- Controllers
- PMEC /AMEC
- PSEP /ASEP
- ROBO NET
- ERC2
- PCON
- ACON
- SCON
- PSEL
- ASEL
- SSEL
- XSEL
- Pulse Motor
- Servo Motor (24V)
- Servo Motor (200V)
- Linear Servo Motor

RCACR-SA4C

Cleanroom ROBO Cylinder Slider Coupling Type 40mm Width 24V Servo Motor Aluminum Base

■ Configuration: **RCACR-SA4C** — — **20** — — — — —

Series — Type — Encoder — Motor — Lead — Stroke — Compatible Controllers — Cable Length — Option

I: Incremental
A: Absolute
* The absolute model can only use ASEL. The simple absolute type is considered an incremental model.

20: 20W servo motor
10: 10mm
5: 5mm
2.5: 2.5mm

50: 50mm
400: 400mm (50mm pitch increments)

A1: ACON
RACON
ASEL
A3: AMEC
ASEP

N: None
P: 1m
S: 3m
M: 5m
X : Custom
R : Robot cable

See Options below

* See page Pre-35 for an explanation of the naming convention.

Power-saving



Technical References P. A-5

- POINT** Notes on Selection
- When the stroke increases, the maximum speed will drop to prevent the ball screw from reaching the critical rotational speed. Use the actuator specification table below to check the maximum speed at the stroke you desire.
 - The load capacity is based on operation at an acceleration of 0.3G (0.2G for the 2.5mm-lead model). This is the upper limit of the acceleration.

Actuator Specifications

■ Lead and Load Capacity

Model	Motor Output (W)	Lead (mm)	Max. Load Capacity		Rated Thrust (N)	Stroke (mm)
			Horizontal (kg)	Vertical (kg)		
RCACR-SA4C-①-20-10-②-③-④-⑤	20	10	4	1	19.6	50 ~ 400 (50mm increments)
RCACR-SA4C-①-20-5-②-③-④-⑤		5	6	2.5	39.2	
RCACR-SA4C-①-20-2.5-②-③-④-⑤		2.5	8	4.5	78.4	

Legend: ① Encoder ② Stroke ③ Compatible controller ④ Cable length ⑤ Options

■ Stroke, Max. Speed/Suction Volume

Stroke Lead	50 ~ 400 (50mm increments)		Suction Volume (NL/min)
	Stroke	Max. Speed	
10	665	50	
5	330	30	
2.5	165	15	

(Unit: mm/s)

① Encoder & Stroke List

Stroke (mm)	Standard Price	
	Encoder Type	
	Incremental	Absolute
50	-	-
100	-	-
150	-	-
200	-	-
250	-	-
300	-	-
350	-	-
400	-	-

④ Cable List

Type	Cable Symbol	Standard Price
Standard Type	P (1m)	-
	S (3m)	-
	M (5m)	-
Special Lengths	X06 (6m) ~ X10 (10m)	-
	X11 (11m) ~ X15 (15m)	-
	X16 (16m) ~ X20 (20m)	-
	R01 (1m) ~ R03 (3m)	-
Robot Cable	R04 (4m) ~ R05 (5m)	-
	R06 (6m) ~ R10 (10m)	-
	R11 (11m) ~ R15 (15m)	-
	R16 (16m) ~ R20 (20m)	-
	-	-

* See page A-39 for cables for maintenance.

⑤ Option List

Name	Option Code	See Page	Standard Price
Brake	B	→ A-25	-
Foot bracket	FT	→ A-29	-
Home sensor	HS	→ A-32	-
Power-saving	LA	→ A-32	-
Reversed-home	NM	→ A-33	-
Slider spacer	SS	→ A-36	-
Intake port mounted on opposite side	VR	→ A-38	-

Actuator Specifications

Item	Description
Drive System	Ball screw ø8mm C10 grade
Positioning Repeatability	±0.02mm
Lost Motion	0.05mm or less
Base	Material: Aluminum (white alumite treated)
Allowable Static Moment	Ma: 6.9N·m Mb: 9.9N·m Mc: 17.0N·m
Allowable Dynamic Moment (*)	Ma: 2.7N·m Mb: 3.9N·m Mc: 6.8N·m
Overhang Load Length	Ma direction: 120mm or less; Mb-Mc direction: 120mm or less
Grease Type	Low dust generation grease (both ball screw and guide)
Cleanliness	Class 10 (0.1µm)
Ambient Operating Temp./Humidity	0~40°C, 85% RH or less (non-condensing)

(*) Based on a 5,000km service life.

Directions of Allowable Load Moments

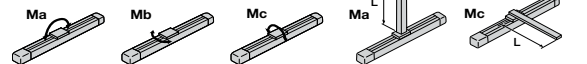

415 RCACR-SA4C

Dimensions

For Special Orders P. A-9

- *1 The motor-encoder cable is connected here. See page A-39 for details on cables.
- *2 When homing, the slider moves to the ME; therefore, please watch for any interference with the surrounding objects.
ME: Mechanical end SE: Stroke end
- *3 Reference position for calculating the moment Ma.
- *4 If the actuator is secured using only the mounting holes provided on the top surface of the base, the base may twist to cause abnormal sliding of the slider, or may produce abnormal noise. Therefore, when using the mounting holes on the top surface of the base, keep the stroke at 200mm or less.

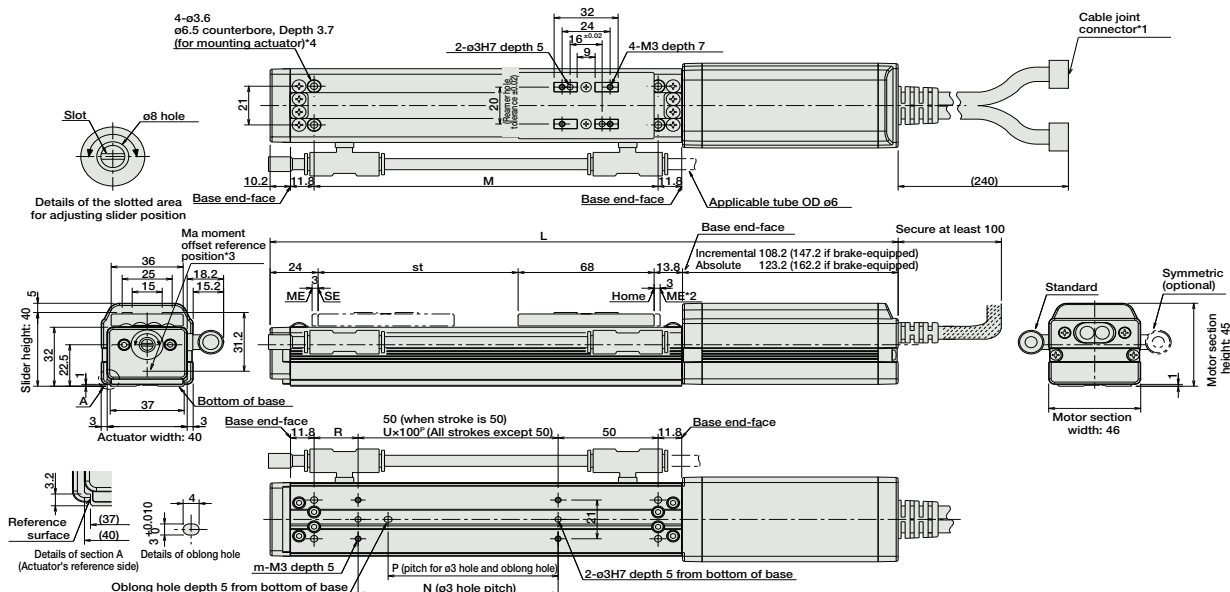

■ Dimensions and Weight by Stroke * Adding a brake will increase the actuator's weight by 0.3kg.

L	Stroke	Stroke							
		50	100	150	200	250	300	350	400
Incremental	No Brake	264	314	364	414	464	514	564	614
	With Brake	303	353	403	453	503	553	603	653
Absolute	No Brake	279	329	379	429	479	529	579	629
	With Brake	318	368	418	468	518	568	618	668
M		122	172	222	272	322	372	422	472
N		50	100	100	200	200	300	300	400
P		35	85	85	185	185	285	285	385
R		22	22	72	22	72	22	72	22
U		-	1	1	2	2	3	3	4
m		4	4	4	6	6	8	8	10
Weight (kg)		0.7	0.8	0.9	1	1.1	1.2	1.3	1.4

③ Compatible Controllers

The RCACR series actuators can operate with the controllers below. Select the controller according to your usage.

Name	External View	Model	Description	Max. Positioning Points	Input Voltage	Power Supply Capacity	Standard Price	See Page
Solenoid Valve Type		AMEC-C-20I②-NP-2-1	Easy-to-use controller, even for beginners	3 points	AC100V	2.4A rated	-	→ P477
		ASEP-C-20I②-NP-2-0	Operable with same signal as solenoid valve. Supports both single and double solenoid types. No homing necessary with simple absolute type.					→ P487
Splash-Proof Solenoid Valve Type		ASEP-CW-20I②-NP-2-0						
Positioner Type		ACON-C-20I②-NP-2-0	Positioning is possible for up to 512 points	512 points	DC24V	(Standard) 1.3A rated 4.4A max.	-	
Safety-Compliant Positioner Type		ACON-CG-20I②-NP-2-0						
Pulse Train Input Type (Differential Line Driver)		ACON-PL-20I②-NP-2-0	Pulse train input type with differential line driver support	(-)	DC24V	(Power-saving) 1.3A rated 2.5A max.	-	→ P535
Pulse Train Input Type (Open Collector)		ACON-PO-20I②-NP-2-0	Pulse train input type with open collector support					
Serial Communication Type		ACON-SE-20I②-N-0-0	Dedicated to serial communication	64 points				
Field Network Type		RACON-20②	Dedicated to field network	768 points				→ P503
Program Control Type		ASEL-C-1-20①②-NP-2-0	Programmed operation is possible. Operation is possible on up to 2 axes	1500 points				→ P567

* This is for the single-axis ASEL.
 * ① is a placeholder for the encoder type (I: incremental / A: absolute).
 * ② is a placeholder for the code "LA" if the power-saving option is specified.



RCACR-SA4C

416

- Slider Type
- Mini
- Standard
- Controllers Integrated
- Rod Type
- Mini
- Standard
- Controllers Integrated
- Table/Arm /Flat Type
- Mini
- Standard
- Gripper/ Rotary Type
- Linear Servo Type
- Cleanroom Type
- Splash Proof
- Controllers
- PMEC /AMEC
- PSEP /ASEP
- ROBO NET
- ERC2
- PCON
- ACON
- SCON
- PSEL
- ASEL
- SSEL
- XSEL
- Pulse Motor
- Servo Motor (24V)
- Servo Motor (200V)
- Linear Servo Motor

RCACR-SA5C

Cleanroom ROBO Cylinder Slider Coupling Type 52mm Width 24V Servo Motor Aluminum Base

■ Configuration: **RCACR-SA5C** — — **20** — — — — —

Series — Type — Encoder — Motor — Lead — Stroke — Compatible Controllers — Cable Length — Option

I : Incremental 20 : 20W servo motor 12:12mm 50: 50mm A1: ACON N : None
 A : Absolute motor 6 : 6mm 3: 3mm 500: 500mm RACON P : 1m
 * The absolute model can only use ASEL. The simple absolute type is considered an incremental model. ASEL M : 5m
 A3: AMEC ASEP X : Custom R : Robot cable

* See page Pre-35 for an explanation of the naming convention.

Power-saving

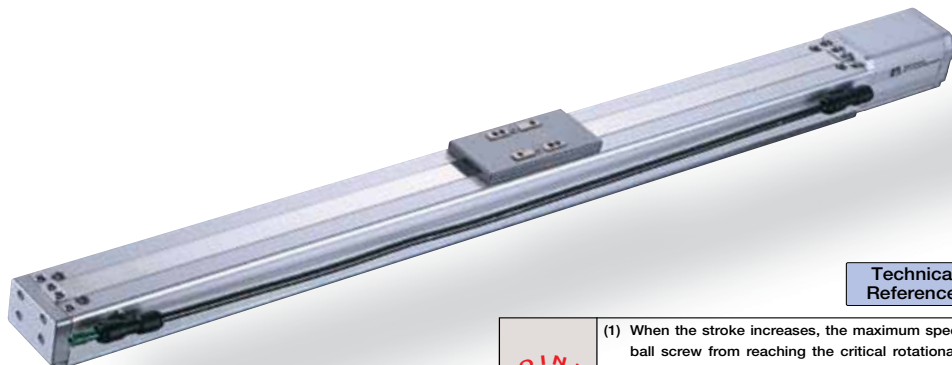

Technical References P. A-5

- POINT** Notes on Selection
- (1) When the stroke increases, the maximum speed will drop to prevent the ball screw from reaching the critical rotational speed. Use the actuator specification table below to check the maximum speed at the stroke you desire.
 - (2) The load capacity is based on operation at an acceleration of 0.3G (0.2G for the 3mm-lead model). This is the upper limit of the acceleration.

Actuator Specifications

■ Lead and Load Capacity

Model	Motor Output (W)	Lead (mm)	Max. Load Capacity		Rated Thrust (N)	Stroke (mm)
			Horizontal (kg)	Vertical (kg)		
RCACR-SA5C-①-20-12-②-③-④-⑤	20	12	4	1	16.7	50 ~ 500 (50mm increments)
RCACR-SA5C-①-20-6-②-③-④-⑤		6	8	2	33.3	
RCACR-SA5C-①-20-3-②-③-④-⑤		3	12	4	65.7	

Legend: ① Encoder ② Stroke ③ Compatible controller ④ Cable length ⑤ Options

■ Stroke, Max. Speed/Suction Volume

Stroke Lead	50 ~ 450 (50mm increments)		500 (mm)	Suction Volume (Nl/min)
	Stroke	Max. Speed		
12	800	760	50	
6	400	380	30	
3	200	190	15	

(Unit: mm/s)

① Encoder & Stroke List

Stroke (mm)	Standard Price	
	Encoder Type	
	Incremental	Absolute
50	-	-
100	-	-
150	-	-
200	-	-
250	-	-
300	-	-
350	-	-
400	-	-
450	-	-
500	-	-

④ Cable List

Type	Cable Symbol	Standard Price
Standard Type	P (1m)	-
	S (3m)	-
	M (5m)	-
Special Lengths	X06 (6m) ~ X10 (10m)	-
	X11 (11m) ~ X15 (15m)	-
	X16 (16m) ~ X20 (20m)	-
	R01 (1m) ~ R03 (3m)	-
Robot Cable	R04 (4m) ~ R05 (5m)	-
	R06 (6m) ~ R10 (10m)	-
	R11 (11m) ~ R15 (15m)	-
	R16 (16m) ~ R20 (20m)	-

* See page A-39 for cables for maintenance.

⑤ Option List

Name	Option Code	See Page	Standard Price
Brake	B	→ A-25	-
Foot bracket	FT	→ A-29	-
Home sensor	HS	→ A-32	-
Power-saving	LA	→ A-32	-
Reversed-home	NM	→ A-33	-
Intake port mounted on opposite side	VR	→ A-38	-

Actuator Specifications

Item	Description
Drive System	Ball screw ø10mm C10 grade
Positioning Repeatability	±0.02mm
Lost Motion	0.1mm or less
Base	Material: Aluminum (white alumite treated)
Allowable Static Moment	Ma: 18.6N·m Mb: 26.6N·m Mc: 47.5N·m
Allowable Dynamic Moment (*)	Ma: 4.9N·m Mb: 6.8N·m Mc: 11.7N·m
Overhang Load Length	Ma direction: 150mm or less; Mb, Mc direction: 150mm or less
Grease Type	Low dust generation grease (both ball screw and guide)
Cleanliness	Class 10 (0.1µm)
Ambient Operating Temp./Humidity	0~40°C, 85% RH or less (non-condensing)

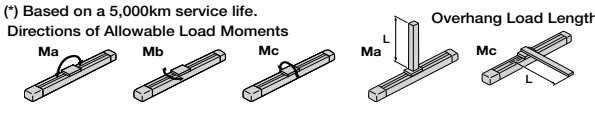

417 RCACR-SA5C

Dimensions

For Special Orders P. A-9

- *1 The motor-encoder cable is connected here. See page A-39 for details on cables.
- *2 After homing, the slider moves to the ME; therefore, please watch for any interference with the surrounding objects.
ME: Mechanical end SE: Stroke end
- *3 Reference position for calculating the moment Ma.

- *4 If the actuator is secured using only the mounting holes provided on the top surface of the base, the base may twist to cause abnormal sliding of the slider, or may produce abnormal noise. Therefore, when using the mounting holes on the top surface of the base, keep the stroke at 300mm or less.

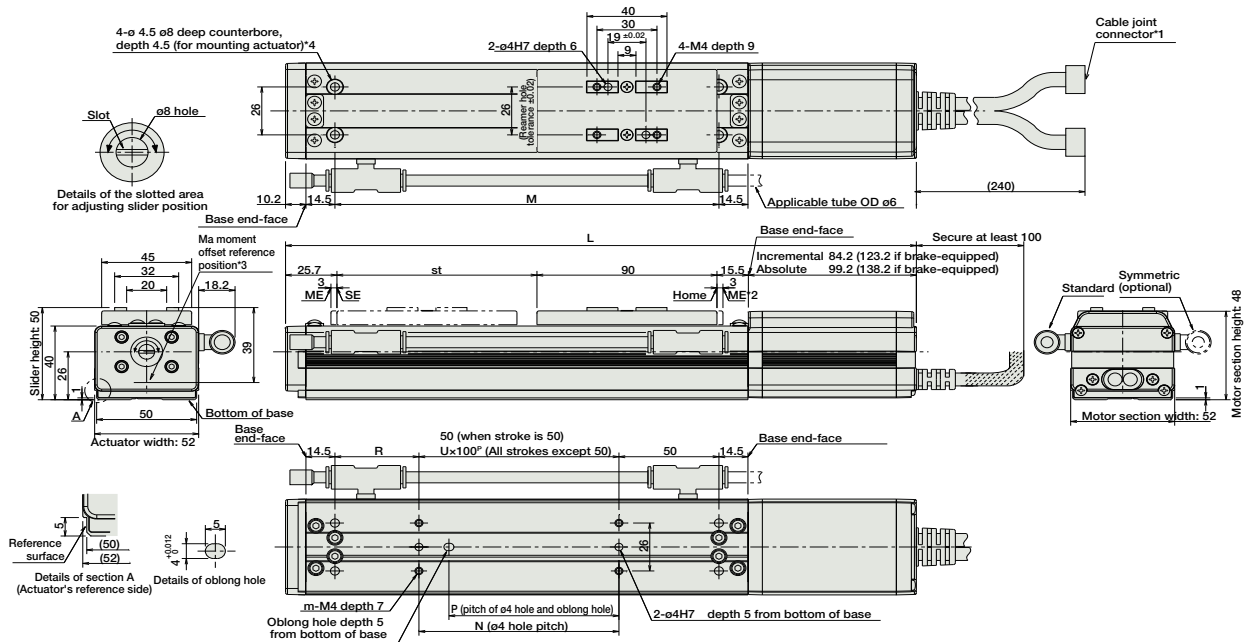

■ Dimensions and Weight by Stroke

* Adding a brake will increase the actuator's weight by 0.3kg.

Stroke	Stroke										
	50	100	150	200	250	300	350	400	450	500	
L	Incremental	265.4	315.4	365.4	415.4	465.4	515.4	565.4	615.4	665.4	715.4
	With Brake	304.4	354.4	404.4	454.4	504.4	554.4	604.4	654.4	704.4	754.4
Absolute	No Brake	280.4	330.4	380.4	430.4	480.4	530.4	580.4	630.4	680.4	730.4
	With Brake	319.4	369.4	419.4	469.4	519.4	569.4	619.4	669.4	719.4	769.4
M	142	192	242	292	342	392	442	492	542	592	
N	50	100	100	200	200	300	300	400	400	500	
P	35	85	85	185	185	285	285	385	385	485	
R	42	42	92	42	92	42	92	42	92	42	
U	-	1	1	2	2	3	3	4	4	5	
m	4	4	4	6	6	8	8	10	10	12	
Weight (kg)	1.3	1.4	1.5	1.6	1.7	1.8	1.9	2	2.1	2.2	

③ Compatible Controllers

The RCACR series actuators can operate with the controllers below. Select the controller according to your usage.

Name	External View	Model	Description	Max. Positioning Points	Input Voltage	Power Supply Capacity	Standard Price	See Page
Solenoid Valve Type		AMEC-C-201②-NP-2-1	Easy-to-use controller, even for beginners	3 points	AC100V	2.4A rated	-	→ P477
		ASEP-C-201②-NP-2-0	Operable with same signal as solenoid valve. Supports both single and double solenoid types. No homing necessary with simple absolute type.					
Splash-Proof Solenoid Valve Type		ASEP-CW-201②-NP-2-0						→ P487
Positioner Type		ACON-C-201②-NP-2-0	Positioning is possible for up to 512 points	512 points	DC24V	(Standard) 1.3A rated 4.4A max.	-	→ P535
Safety-Compliant Positioner Type		ACON-CG-201②-NP-2-0						
Pulse Train Input Type (Differential Line Driver)		ACON-PL-201②-NP-2-0	Pulse train input type with differential line driver support	(-)	DC24V	(Power-saving) 1.3A rated 2.5A max.	-	→ P503
Pulse Train Input Type (Open Collector)		ACON-PO-201②-NP-2-0	Pulse train input type with open collector support					
Serial Communication Type		ACON-SE-201②-N-0-0	Dedicated to serial communication	64 points				
Field Network Type		RACON-20②	Dedicated to field network	768 points				
Program Control Type		ASEL-C-1-20①②-NP-2-0	Programmed operation is possible. Operation is possible on up to 2 axes	1500 points				→ P567

* This is for the single-axis ASEL.
 * ① is a placeholder for the encoder type (I: incremental / A: absolute).
 * ② is a placeholder for the code "LA" if the power-saving option is specified.

- Slider Type
- Mini
- Standard
- Controllers Integrated
- Rod Type
- Mini
- Standard
- Controllers Integrated
- Table/Arm /Flat Type
- Mini
- Standard
- Gripper/ Rotary Type
- Linear Servo Type
- Cleanroom Type
- Splash Proof
- Controllers
- PMEC /AMEC
- PSEP /ASEP
- ROBO NET
- ERC2
- PCON
- ACON
- SCON
- PSEL
- ASEL
- SSEL
- XSEL
- Pulse Motor
- Servo Motor (24V)
- Servo Motor (200V)
- Linear Servo Motor

RCACR-SA6C Cleanroom ROBO Cylinder Slider Coupling Type 58mm Width 24V Servo Motor Aluminum Base

■ Configuration: **RCACR-SA6C** — — **30** — — — — —

Series — Type — Encoder — Motor — Lead — Stroke — Compatible Controllers — Cable Length — Option

I : Incremental 30 : 30W servo 12:12mm 50: 50mm A1: ACON N : None
 A : Absolute motor 6: 6mm 600: 600mm RACON P : 1m
 * The absolute model can only use ASEL. The simple absolute type is considered an incremental model. 3: 3mm (50mm pitch increments) ASEL M : 5m
 A3: AMEC ASEP X : Custom
 R : Robot cable See Options below

* See page Pre-35 for an explanation of the naming convention.

Power-saving

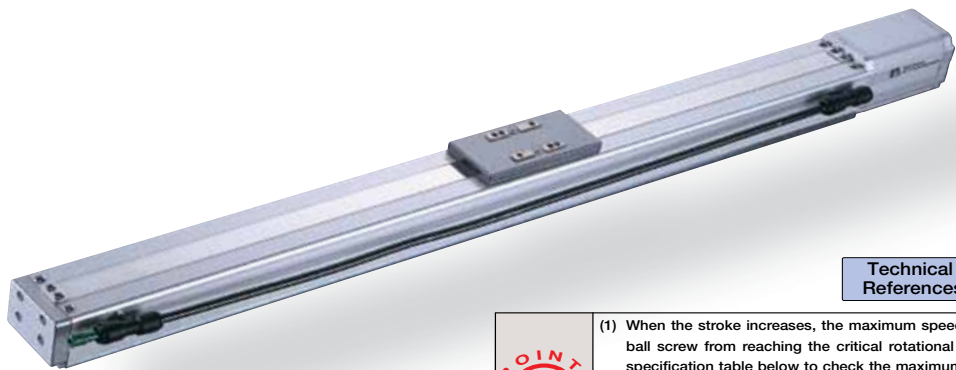

Technical References P. A-5

- POINT** Notes on Selection
- (1) When the stroke increases, the maximum speed will drop to prevent the ball screw from reaching the critical rotational speed. Use the actuator specification table below to check the maximum speed at the stroke you desire.
 - (2) The load capacity is based on operation at an acceleration of 0.3G (0.2G for the 3mm-lead model). This is the upper limit of the acceleration.

Actuator Specifications

■ Lead and Load Capacity

Model	Motor Output (W)	Lead (mm)	Max. Load Capacity		Rated Thrust (N)	Stroke (mm)
			Horizontal (kg)	Vertical (kg)		
RCACR-SA6C-①-30-12-②-③-④-⑤	30	12	6	1.5	24.2	50 ~ 600 (50mm increments)
RCACR-SA6C-①-30-6-②-③-④-⑤		6	12	3	48.4	
RCACR-SA6C-①-30-3-②-③-④-⑤		3	18	6	96.8	

Legend: ① Encoder ② Stroke ③ Compatible controller ④ Cable length ⑤ Options

■ Stroke, Max. Speed/Suction Volume

Stroke / Lead	50 ~ 450 (50mm increments)				Suction Volume (N/min)
	500 (mm)	550 (mm)	600 (mm)	650 (mm)	
12	800	760	640	540	50
6	400	380	320	270	30
3	200	190	160	135	15

(Unit: mm/s)

① Encoder & Stroke List

Stroke (mm)	Standard Price	
	Encoder Type	
	Incremental	Absolute
50	-	-
100	-	-
150	-	-
200	-	-
250	-	-
300	-	-
350	-	-
400	-	-
450	-	-
500	-	-
550	-	-
600	-	-

④ Cable List

Type	Cable Symbol	Standard Price
Standard Type	P (1m)	-
	S (3m)	-
	M (5m)	-
Special Lengths	X06 (6m) ~ X10 (10m)	-
	X11 (11m) ~ X15 (15m)	-
	X16 (16m) ~ X20 (20m)	-
	R01 (1m) ~ R03 (3m)	-
Robot Cable	R04 (4m) ~ R05 (5m)	-
	R06 (6m) ~ R10 (10m)	-
	R11 (11m) ~ R15 (15m)	-
	R16 (16m) ~ R20 (20m)	-

* See page A-39 for cables for maintenance.

⑤ Option List

Name	Option Code	See Page	Standard Price
Brake	B	→ A-25	-
Foot bracket	FT	→ A-29	-
Home sensor	HS	→ A-32	-
Power-saving	LA	→ A-32	-
Reversed-home	NM	→ A-33	-
Intake port mounted on opposite side	VR	→ A-38	-

Actuator Specifications

Item	Description
Drive System	Ball screw ø10mm C10 grade
Positioning Repeatability	±0.02mm
Lost Motion	0.1mm or less
Base	Material: Aluminum (white alumite treated)
Allowable Static Moment	Ma: 38.3N·m Mb: 54.7N·m Mc: 81.0N·m
Allowable Dynamic Moment (*)	Ma: 8.9N·m Mb: 12.7N·m Mc: 18.6N·m
Overhang Load Length	Ma direction: 220mm or less; Mb, Mc directions: 220mm or less
Grease Type	Low dust generation grease (both ball screw and guide)
Cleanliness	Class 10 (0.1µm)
Ambient Operating Temp./Humidity	0~40°C, 85% RH or less (non-condensing)

(*) Based on a 5,000km service life.

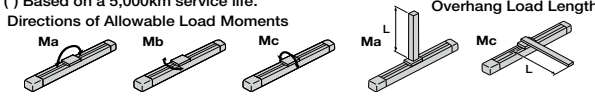

419 RCACR-SA6C

Dimensions

For Special Orders P. A-9

- *1 The motor-encoder cable is connected here. See page A-39 for details on cables.
- *2 After homing, the slider moves to the ME; therefore, please watch for any interference with the surrounding objects.
ME: Mechanical end SE: Stroke end
- *3 Reference position for calculating the moment Ma.

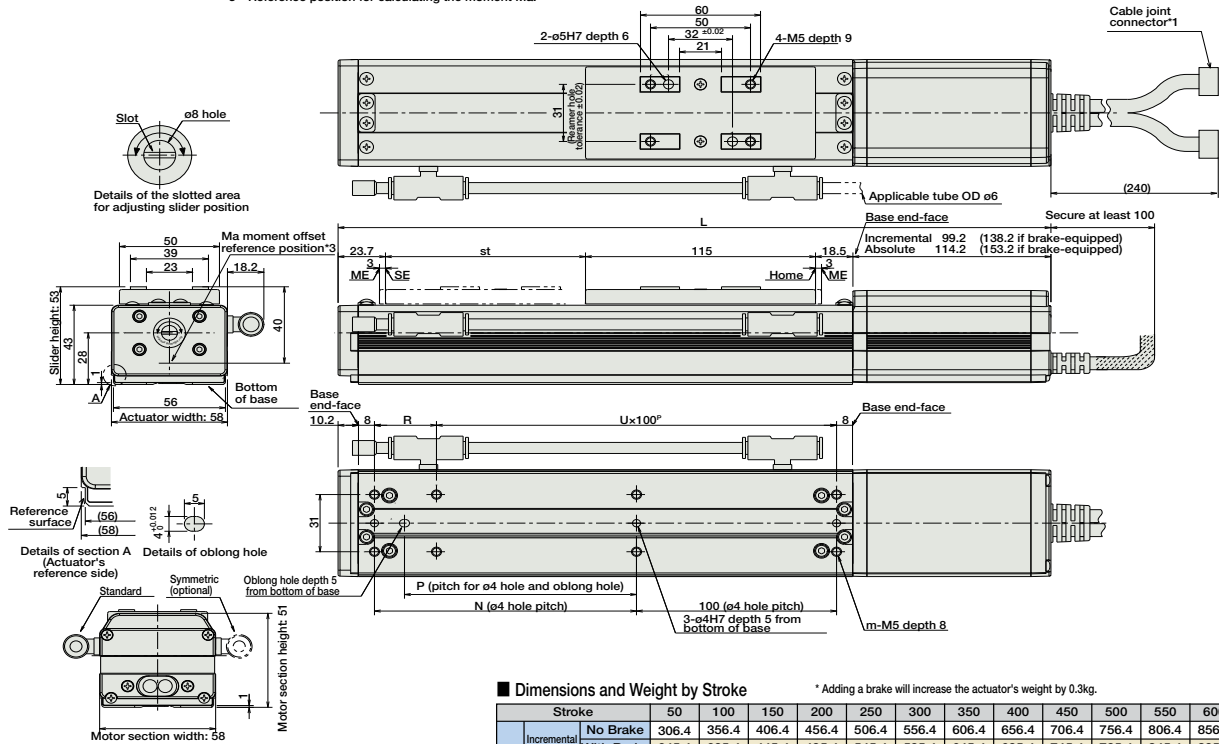

■ Dimensions and Weight by Stroke

* Adding a brake will increase the actuator's weight by 0.3kg.

Stroke	50	100	150	200	250	300	350	400	450	500	550	600	
L	Incremental	No Brake	306.4	356.4	406.4	456.4	506.4	556.4	606.4	656.4	706.4	756.4	806.4
		With Brake	345.4	395.4	445.4	495.4	545.4	595.4	645.4	695.4	745.4	795.4	845.4
L	Absolute	No Brake	321.4	371.4	421.4	471.4	521.4	571.4	621.4	671.4	721.4	771.4	821.4
		With Brake	360.4	410.4	460.4	510.4	560.4	610.4	660.4	710.4	760.4	810.4	860.4
N	81	131	181	231	281	331	381	431	481	531	581	631	
P	66	116	166	216	266	316	366	416	466	516	566	616	
R	81	31	81	31	81	31	81	31	81	31	81	31	
U	1	2	2	3	3	4	4	5	5	6	6	7	
m	6	8	8	10	10	12	12	14	14	16	16	18	
Weight (kg)	1.4	1.6	1.8	2	2.2	2.4	2.6	2.8	3	3.2	3.4	3.6	

③ Compatible Controllers

The RCACR series actuators can operate with the controllers below. Select the controller according to your usage.

Name	External View	Model	Description	Max. Positioning Points	Input Voltage	Power Supply Capacity	Standard Price	See Page
Solenoid Valve Type		AMEC-C-30I②-NP-2-1	Easy-to-use controller, even for beginners	3 points	AC100V	2.4A rated	-	→ P477
		ASEP-C-30I②-NP-2-0	Operable with same signal as solenoid valve. Supports both single and double solenoid types. No homing necessary with simple absolute type.					→ P487
Splash-Proof Solenoid Valve Type		ASEP-CW-30I②-NP-2-0						
Positioner Type		ACON-C-30I②-NP-2-0	Positioning is possible for up to 512 points	512 points	DC24V	(Standard) 1.3A rated 4.4A max.	-	
Safety-Compliant Positioner Type		ACON-CG-30I②-NP-2-0						
Pulse Train Input Type (Differential Line Driver)		ACON-PL-30I②-NP-2-0	Pulse train input type with differential line driver support	(-)	DC24V	(Power-saving) 1.3A rated 2.2A max.	-	→ P535
Pulse Train Input Type (Open Collector)		ACON-PO-30I②-NP-2-0	Pulse train input type with open collector support					
Serial Communication Type		ACON-SE-30I②-N-0-0	Dedicated to serial communication	64 points				
Field Network Type		RACON-30②	Dedicated to field network	768 points				→ P503
Program Control Type		ASEL-C-1-30①②-NP-2-0	Programmed operation is possible. Operation is possible on up to 2 axes	1500 points				→ P567

* This is for the single-axis ASEL.
 * ① is a placeholder for the encoder type (I: incremental / A: absolute).
 * ② is a placeholder for the code "LA" if the power-saving option is specified.

- Slider Type
- Mini
- Standard
- Controllers Integrated
- Rod Type
- Mini
- Standard
- Controllers Integrated
- Table/Arm /Flat Type
- Mini
- Standard
- Gripper/ Rotary Type
- Linear Servo Type
- Cleanroom Type
- Splash Proof
- Controllers
- PMEC /AMEC
- PSEP /ASEP
- ROBO NET
- ERC2
- PCON
- ACON
- SCON
- PSEL
- ASEL
- SSEL
- XSEL
- Pulse Motor
- Servo Motor (24V)
- Servo Motor (200V)
- Linear Servo Motor

RCACR-SA5D

Cleanroom ROBO Cylinder Slider Built-In Type 52mm Width 24V Servo Motor Aluminum Base

■ Configuration: **RCACR-SA5D** — — **20** — — — — —

Series — Type — Encoder — Motor — Lead — Stroke — Compatible Controllers — Cable Length — Option

I : Incremental 20 : 20W servo motor 12:12mm 50: 50mm A1: ACON N : None
 A : Absolute motor 6 : 6mm 500: 500mm RACON P : 1m
 * The absolute model can only use ASEL. The simple absolute type is considered an incremental model. ASEL M : 5m
 A3: AMEC ASEP X : Custom
 R : Robot cable See Options below

* See page Pre-35 for an explanation of the naming convention.

Power-saving



Technical References P. A-5

- POINT** Notes on Selection
- (1) When the stroke increases, the maximum speed will drop to prevent the ball screw from reaching the critical rotational speed. Use the actuator specification table below to check the maximum speed at the stroke you desire.
 - (2) The load capacity is based on operation at an acceleration of 0.3G (0.2G for the 3mm-lead model). This is the upper limit of the acceleration.
 - (3) The cleanliness class 10 is for horizontal usage. Please note that the actuator may not support C10 when used on its side or in vertical orientation.

Actuator Specifications

■ Lead and Load Capacity

Model	Motor Output (W)	Lead (mm)	Max. Load Capacity		Rated Thrust (N)	Stroke (mm)
			Horizontal (kg)	Vertical (kg)		
RCACR-SA5D-①-20-12-②-③-④-⑤	20	12	4	1	16.7	50 ~ 500 (50mm increments)
RCACR-SA5D-①-20-6-②-③-④-⑤		6	8	2	33.3	
RCACR-SA5D-①-20-3-②-③-④-⑤		3	12	4	65.7	

Legend: ① Encoder ② Stroke ③ Compatible controller ④ Cable length ⑤ Options

■ Stroke, Max. Speed/Suction Volume

Lead	Stroke (50mm increments)	50 ~ 450 (50mm increments)		Suction Volume (N/min)
		500 (mm)	500 (mm)	
12	800	760	50	
6	400	380	30	
3	200	190	15	

(Unit: mm/s)

① Encoder & Stroke List

Stroke (mm)	Standard Price	
	Encoder Type	
	Incremental	Absolute
50	-	-
100	-	-
150	-	-
200	-	-
250	-	-
300	-	-
350	-	-
400	-	-
450	-	-
500	-	-

④ Cable List

Type	Cable Symbol	Standard Price
Standard Type	P (1m)	-
	S (3m)	-
	M (5m)	-
Special Lengths	X06 (6m) ~ X10 (10m)	-
	X11 (11m) ~ X15 (15m)	-
	X16 (16m) ~ X20 (20m)	-
	R01 (1m) ~ R03 (3m)	-
Robot Cable	R04 (4m) ~ R05 (5m)	-
	R06 (6m) ~ R10 (10m)	-
	R11 (11m) ~ R15 (15m)	-
	R16 (16m) ~ R20 (20m)	-

* See page A-39 for cables for maintenance.

⑤ Option List

Name	Option Code	See Page	Standard Price
Brake (Cable exiting from end)	BE	→ A-25	-
Brake (Cable exiting from left)	BL	→ A-25	-
Brake (Cable exiting from right)	BR	→ A-25	-
Power-saving	LA	→ A-32	-
Reversed-home	NM	→ A-33	-
Intake port mounted on opposite side	VR	→ A-38	-

Actuator Specifications

Item	Description
Drive System	Ball screw ø10mm C10 grade
Positioning Repeatability	±0.02mm
Lost Motion	0.1mm or less
Base	Material: Aluminum (white alumite treated)
Allowable Static Moment	Ma: 18.6N·m Mb: 26.6N·m Mc: 47.5N·m
Allowable Dynamic Moment (*)	Ma: 4.9N·m Mb: 6.8N·m Mc: 11.7N·m
Overhang Load Length	Ma direction: 150mm or less; Mb, Mc direction: 150mm or less
Grease Type	Low dust generation grease (both ball screw and guide)
Cleanliness	Class 10 (0.1µm)
Ambient Operating Temp./Humidity	0~40°C, 85% RH or less (non-condensing)

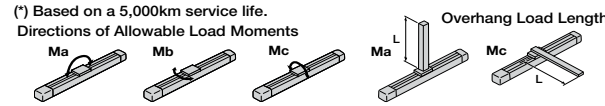

421 RCACR-SA5D

Dimensions

For Special Orders P. A-9

- *1 The motor-encoder cable is connected here. See page A-39 for details on cables.
- *2 After homing, the slider moves to the ME; therefore, please watch for any interference with the surrounding objects.
ME: Mechanical end SE: Stroke end
- *3 Reference position for calculating the moment Ma.
- *4 If the actuator is secured using only the mounting holes provided on the top surface of the base, the base may twist to cause abnormal sliding of the slider, or may produce abnormal noise. Therefore, when using the mounting holes on the top surface of the base, keep the stroke at 300mm or less.

* Note that in order to change the home orientation, arrangements must be made to send in the product to IAI.

* In the reversed-home model (NM), the new home position is set 3mm inward from the ME opposite of the motor-side.

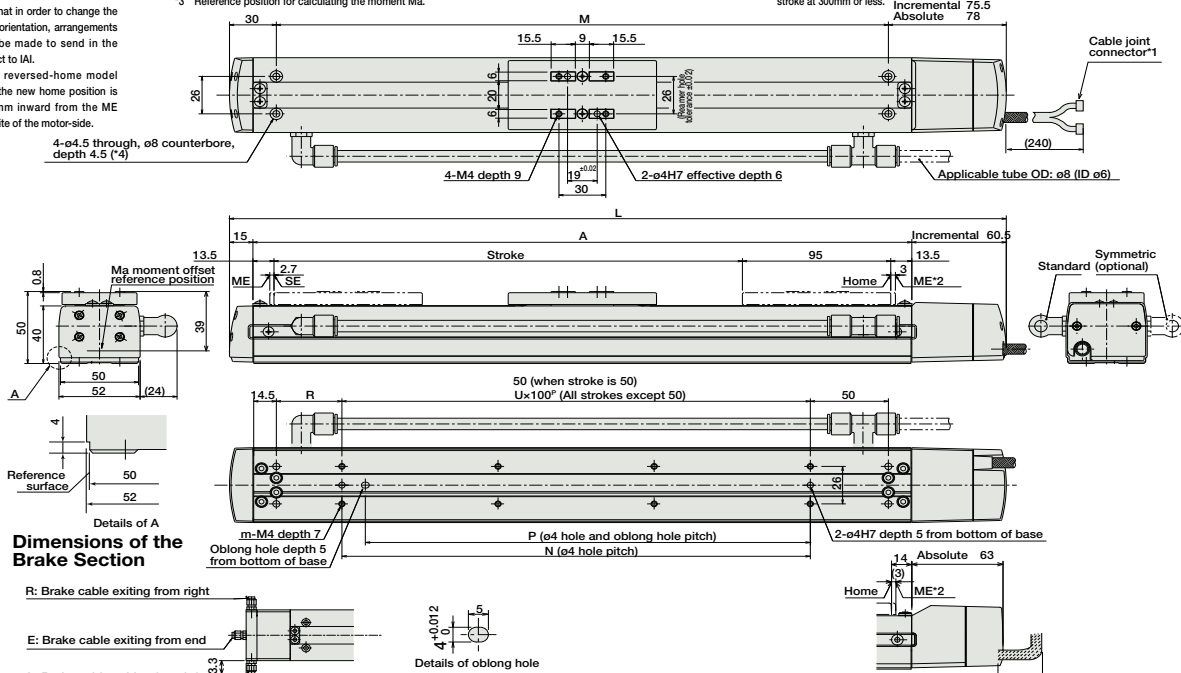

Dimensions of the Brake Section

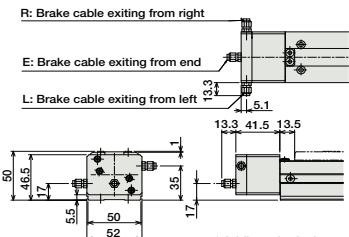

* Adding a brake increases the actuator's overall length (L) by 26.5mm (39.8mm with the cable coming out the end), and its weight by 0.3kg.

■ Dimensions and Weight by Stroke

Stroke	50	100	150	200	250	300	350	400	450	500
L	Incremental	247.5	297.5	347.5	397.5	447.5	497.5	547.5	597.5	647.5
	Absolute	250	300	350	400	450	500	550	600	650
A	172	222	272	322	372	422	472	522	572	622
M	142	192	242	292	342	392	442	492	542	592
N	50	100	100	200	200	300	300	400	400	500
P	35	85	85	185	185	285	285	385	385	485
R	42	42	92	42	92	42	92	42	92	42
U	-	1	1	2	2	3	3	4	4	5
m	4	4	4	6	6	8	8	10	10	12
Weight (kg)	1.2	1.3	1.4	1.5	1.6	1.7	1.8	1.9	2.0	2.1

Secure at least 100

③ Compatible Controllers

The RCACR series actuators can operate with the controllers below. Select the controller according to your usage.

Name	External View	Model	Description	Max. Positioning Points	Input Voltage	Power Supply Capacity	Standard Price	See Page
Solenoid Valve Type		AMEC-C-201②-NP-2-1	Easy-to-use controller, even for beginners	3 points	AC100V	2.4A rated	-	→ P477
		ASEP-C-201②-NP-2-0	Operable with same signal as solenoid valve. Supports both single and double solenoid types. No homing necessary with simple absolute type.					→ P487
Splash-Proof Solenoid Valve Type		ASEP-CW-201②-NP-2-0						
Positioner Type		ACON-C-201②-NP-2-0	Positioning is possible for up to 512 points	512 points	DC24V	(Standard) 1.3A rated 4.4A max.	-	
Safety-Compliant Positioner Type		ACON-CG-201②-NP-2-0						
Pulse Train Input Type (Differential Line Driver)		ACON-PL-201②-NP-2-0	Pulse train input type with differential line driver support	(-)	DC24V	(Power-saving) 1.3A rated 2.5A max.	-	→ P535
Pulse Train Input Type (Open Collector)		ACON-PO-201②-NP-2-0	Pulse train input type with open collector support					
Serial Communication Type		ACON-SE-201②-N-0-0	Dedicated to serial communication	64 points				
Field Network Type		RACON-20②	Dedicated to field network	768 points				→ P503
Program Control Type		ASEL-C-1-20①②-NP-2-0	Programmed operation is possible. Operation is possible on up to 2 axes	1500 points				→ P567

* This is for the single-axis ASEL.
 * ① is a placeholder for the encoder type (I: incremental / A: absolute).
 * ② is a placeholder for the code *LA* if the power-saving option is specified.

- Slider Type
- Mini
- Standard
- Controllers Integrated
- Rod Type
- Mini
- Standard
- Controllers Integrated
- Table/Arm /Flat Type
- Mini
- Standard
- Gripper/ Rotary Type
- Linear Servo Type
- Cleanroom Type
- Splash Proof
- Controllers
- PMEC /AMEC
- PSEP /ASEP
- ROBO NET
- ERC2
- PCON
- ACON
- SCON
- PSEL
- ASEL
- SSEL
- XSEL
- Pulse Motor
- Servo Motor (24V)
- Servo Motor (200V)
- Linear Servo Motor

RCACR-SA6D

Cleanroom ROBO Cylinder Slider Built-In Type 58mm Width 24V Servo Motor Aluminum Base

■ Configuration: **RCACR-SA6D** — — **30** — — — — —

Series — Type — Encoder — Motor — Lead — Stroke — Compatible Controllers — Cable Length — Option

I : Incremental 30 : 30W servo motor 12:12mm 50: 50mm A1: ACON N : None
 A : Absolute 6 : 6mm 600: 600mm RACON P : 1m
 The absolute model can only use ASEL. The simple absolute type is considered an incremental model. A3: AMEC ASEP M : 5m
 X : Custom
 R : Robot cable

* See page Pre-35 for an explanation of the naming convention.

Power-saving



Technical References P. A-5

- POINT** Notes on Selection
- When the stroke increases, the maximum speed will drop to prevent the ball screw from reaching the critical rotational speed. Use the actuator specification table below to check the maximum speed at the stroke you desire.
 - The load capacity is based on operation at an acceleration of 0.3G (0.2G for the 3mm-lead model). This is the upper limit of the acceleration.
 - The cleanliness class 10 is for horizontal usage. Please note that the actuator may not support C10 when used on its side or in vertical orientation.

Actuator Specifications

■ Lead and Load Capacity

Model	Motor Output (W)	Lead (mm)	Max. Load Capacity		Rated Thrust (N)	Stroke (mm)
			Horizontal (kg)	Vertical (kg)		
RCACR-SA6D-①-30-12-②-③-④-⑤	30	12	6	1.5	24.2	50 ~ 600 (50mm increments)
RCACR-SA6D-①-30-6-②-③-④-⑤		6	12	3	48.4	
RCACR-SA6D-①-30-3-②-③-④-⑤		3	18	6	96.8	

Legend: ① Encoder ② Stroke ③ Compatible controller ④ Cable length ⑤ Options

■ Stroke, Max. Speed/Suction Volume

Stroke / Lead	50 ~ 450 (50mm increments)	500 (mm)	550 (mm)	600 (mm)	Suction Volume (N/min)
12	800	760	640	540	50
6	400	380	320	270	30
3	200	190	160	135	15

(Unit: mm/s)

① Encoder & Stroke List

Stroke (mm)	Standard Price	
	Encoder Type	
	Incremental	Absolute
50	-	-
100	-	-
150	-	-
200	-	-
250	-	-
300	-	-
350	-	-
400	-	-
450	-	-
500	-	-
550	-	-
600	-	-

④ Cable List

Type	Cable Symbol	Standard Price
Standard Type	P (1m)	-
	S (3m)	-
	M (5m)	-
Special Lengths	X06 (6m) ~ X10 (10m)	-
	X11 (11m) ~ X15 (15m)	-
	X16 (16m) ~ X20 (20m)	-
	R01 (1m) ~ R03 (3m)	-
Robot Cable	R04 (4m) ~ R05 (5m)	-
	R06 (6m) ~ R10 (10m)	-
	R11 (11m) ~ R15 (15m)	-
	R16 (16m) ~ R20 (20m)	-

* See page A-39 for cables for maintenance.

⑤ Option List

Name	Option Code	See Page	Standard Price
Brake (Cable exiting from end)	BE	→ A-25	-
Brake (Cable exiting from left)	BL	→ A-25	-
Brake (Cable exiting from right)	BR	→ A-25	-
Power-saving	LA	→ A-32	-
Reversed-home	NM	→ A-33	-
Intake port mounted on opposite side	VR	→ A-38	-

Actuator Specifications

Item	Description
Drive System	Ball screw ø10mm C10 grade
Positioning Repeatability	±0.02mm
Lost Motion	0.1mm or less
Base	Material: Aluminum (white alumite treated)
Allowable Static Moment	Ma: 38.3N-m Mb: 54.7N-m Mc: 81.0N-m
Allowable Dynamic Moment (*)	Ma: 8.9N-m Mb: 12.7N-m Mc: 18.6N-m
Overhang Load Length	Ma direction: 220mm or less; Mb, Mc directions: 220mm or less
Grease Type	Low dust generation grease (both ball screw and guide)
Cleanliness	Class 10 (0.1µm)
Ambient Operating Temp./Humidity	0~40°C, 85% RH or less (non-condensing)

(*) Based on a 5,000km service life.

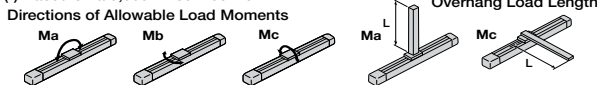

423 RCACR-SA6D

Dimensions

For Special Orders P. A-9

- *1 The motor-encoder cable is connected here. See page A-39 for details on cables.
- *2 After homing, the slider moves to the ME; therefore, please watch for any interference with the surrounding objects.
ME: Mechanical end SE: Stroke end
- *3 Reference position for calculating the moment Ma.

* Note that in order to change the home orientation, arrangements must be made to send in the product to IAI.
* In the reversed-home model (NM), the new home position is set 3mm inward from the ME opposite of the motor-side.

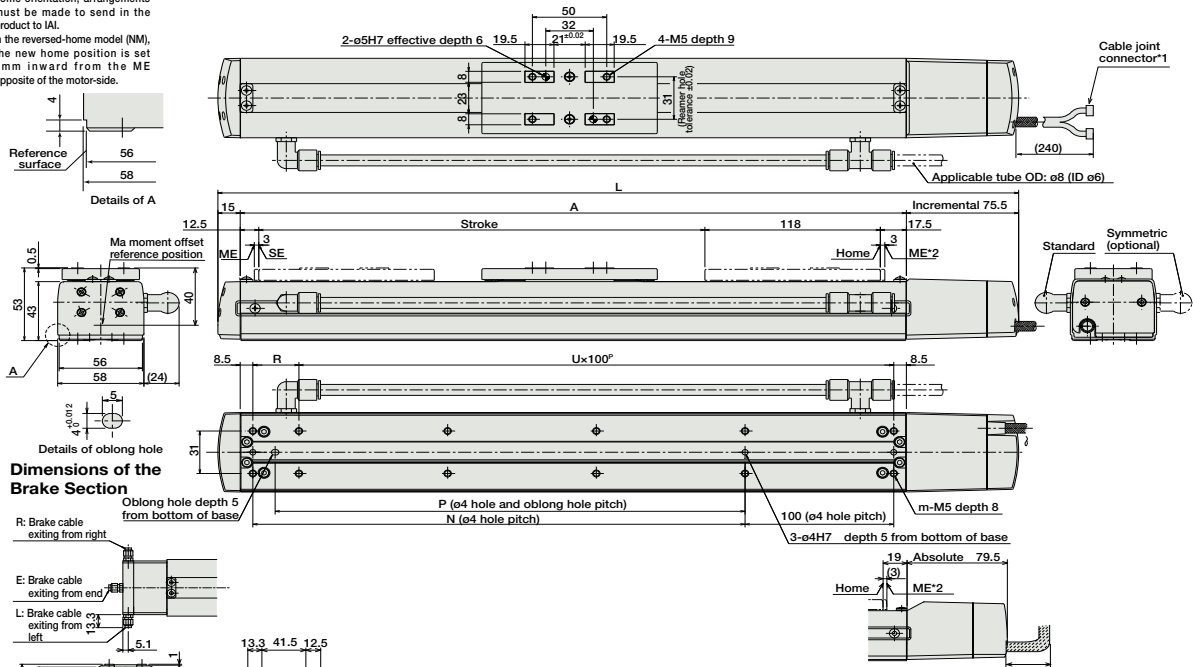

Dimensions of the Brake Section

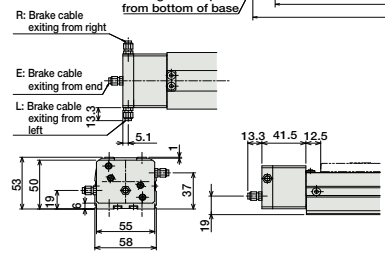

* Adding a brake increases the actuator's overall length (L) by 26.5mm (39.8mm with the cable coming out the end), and its weight by 0.3kg.

■ Dimensions and Weight by Stroke

Stroke	50	100	150	200	250	300	350	400	450	500	550	600	
L	Incremental	288.5	338.5	388.5	438.5	488.5	538.5	588.5	638.5	688.5	738.5	788.5	838.5
	Absolute	292.5	342.5	392.5	442.5	492.5	542.5	592.5	642.5	692.5	742.5	792.5	842.5
A	198	248	298	348	398	448	498	548	598	648	698	748	
N	81	131	181	231	281	331	381	431	481	531	581	631	
P	66	116	166	216	266	316	366	416	466	516	566	616	
R	81	31	81	31	81	31	81	31	81	31	81	31	
U	1	2	2	3	3	4	4	5	5	6	6	7	
m	6	8	8	10	10	12	12	14	14	16	16	18	
Weight (kg)	1.3	1.5	1.7	1.9	2.1	2.3	2.5	2.7	2.9	3.1	3.3	3.5	

③ Compatible Controllers

The RCACR series actuators can operate with the controllers below. Select the controller according to your usage.

Name	External View	Model	Description	Max. Positioning Points	Input Voltage	Power Supply Capacity	Standard Price	See Page
Solenoid Valve Type		AMEC-C-30I②-NP-2-1	Easy-to-use controller, even for beginners	3 points	AC100V	2.4A rated	-	→ P477
		ASEP-C-30I②-NP-2-0	Operable with same signal as solenoid valve. Supports both single and double solenoid types. No homing necessary with simple absolute type.					
Splash-Proof Solenoid Valve Type		ASEP-CW-30I②-NP-2-0						→ P487
Positioner Type		ACON-C-30I②-NP-2-0	Positioning is possible for up to 512 points	512 points	DC24V	(Standard) 1.3A rated 4.4A max.	-	
Safety-Compliant Positioner Type		ACON-CG-30I②-NP-2-0						
Pulse Train Input Type (Differential Line Driver)		ACON-PL-30I②-NP-2-0	Pulse train input type with differential line driver support	(-)	DC24V	(Power-saving) 1.3A rated 2.2A max.	-	→ P535
Pulse Train Input Type (Open Collector)		ACON-PO-30I②-NP-2-0	Pulse train input type with open collector support					
Serial Communication Type		ACON-SE-30I②-N-0-0	Dedicated to serial communication	64 points				
Field Network Type		RACON-30②	Dedicated to field network	768 points				→ P503
Program Control Type		ASEL-C-1-30①②-NP-2-0	Programmed operation is possible. Operation is possible on up to 2 axes	1500 points				→ P567

* This is for the single-axis ASEL.
* ① is a placeholder for the encoder type (I: incremental / A: absolute).
* ② is a placeholder for the code *LA* if the power-saving option is specified.



RCACR-SA6D **424**

- Slider Type
- Mini
- Standard
- Controllers Integrated
- Rod Type
- Mini
- Standard
- Controllers Integrated
- Table/Arm /Flat Type
- Mini
- Standard
- Gripper/ Rotary Type
- Linear Servo Type
- Cleanroom Type
- Splash Proof
- Controllers
- PMEC /AMEC
- PSEP /ASEP
- ROBO NET
- ERC2
- PCON
- ACON
- SCON
- PSEL
- ASEL
- SSEL
- XSEL
- Pulse Motor
- Servo Motor (24V)
- Servo Motor (200V)
- Linear Servo Motor

RCS2CR-SA4C

Cleanroom ROBO Cylinder Slider Coupling Type 40mm Width 200V Servo Motor Aluminum Base

■ Configuration: **RCS2CR** — **SA4C** — — **20** — — — — —

Series — Type — Encoder — Motor — Lead — Stroke — Compatible Controllers — Cable Length — Option

I : Incremental
A : Absolute

20 : 20W servo motor

10 : 10mm
5 : 5mm
2.5 : 2.5mm

50 : 50mm
400 : 400mm (50mm pitch increments)

T1 : XSEL-J/K
T2 : SCON
SSEL
XSEL-P/Q

N : None
P : 1m
S : 3m
M : 5m
X : Custom
R : Robot cable

See Options below

* See page Pre-35 for an explanation of the naming convention.

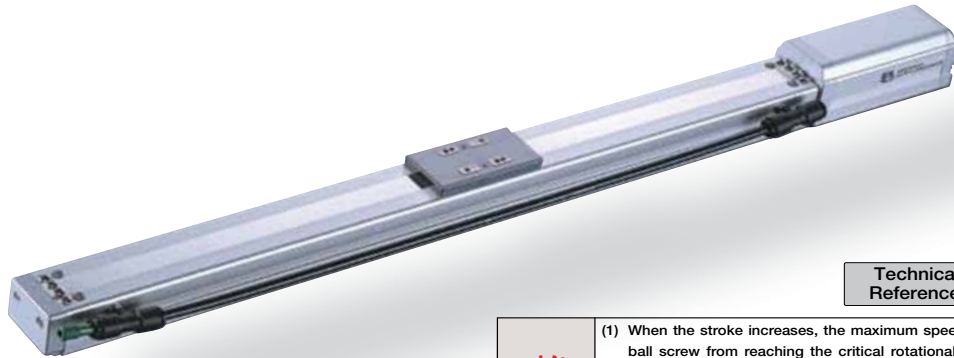

Technical References P. A-5

- POINT**
Notes on Selection
- When the stroke increases, the maximum speed will drop to prevent the ball screw from reaching the critical rotational speed. Use the actuator specification table below to check the maximum speed at the stroke you desire.
 - The load capacity is based on operation at an acceleration of 0.3G (0.2G for the 2.5mm-lead model). This is the upper limit of the acceleration.

Actuator Specifications

Lead and Load Capacity

Model	Motor Output (W)	Lead (mm)	Max. Load Capacity		Rated Thrust (N)	Stroke (mm)
			Horizontal (kg)	Vertical (kg)		
RCS2CR-SA4C-①-20-10-②-③-④-⑤	20	10	4	1	19.6	50~400 (50mm increments)
RCS2CR-SA4C-①-20-5-②-③-④-⑤		5	6	2.5	39.2	
RCS2CR-SA4C-①-20-2.5-②-③-④-⑤		2.5	8	4.5	78.4	

Legend: ① Encoder ② Stroke ③ Compatible controller ④ Cable length ⑤ Options

Stroke, Max. Speed/Suction Volume

Lead	Stroke		Suction Volume (NL/min)
	50 ~ 400 (50mm increments)	50 ~ 400 (50mm increments)	
10	665	50	
5	330	30	
2.5	165	15	

(Unit: mm/s)

① Encoder & Stroke List

Stroke (mm)	Standard Price	
	Encoder Type	
	Incremental	Absolute
50	-	-
100	-	-
150	-	-
200	-	-
250	-	-
300	-	-
350	-	-
400	-	-

④ Cable List

Type	Cable Symbol	Standard Price
Standard Type	P (1m)	-
	S (3m)	-
	M (5m)	-
Special Lengths	X06 (6m) ~ X10 (10m)	-
	X11 (11m) ~ X15 (15m)	-
	X16 (16m) ~ X20 (20m)	-
	R01 (1m) ~ R03 (3m)	-
Robot Cable	R04 (4m) ~ R05 (5m)	-
	R06 (6m) ~ R10 (10m)	-
	R11 (11m) ~ R15 (15m)	-
	R16 (16m) ~ R20 (20m)	-
	-	-

* See page A-39 for cables for maintenance.

⑤ Option List

Name	Option Code	See Page	Standard Price
Brake	B	→ A-25	-
Foot bracket	FT	→ A-29	-
Home sensor	HS	→ A-32	-
Reversed-home	NM	→ A-33	-
Slider spacer	SS	→ A-36	-
Intake port mounted on opposite side	VR	→ A-38	-

Actuator Specifications

Item	Description
Drive System	Ball screw ø8mm C10 grade
Positioning Repeatability	±0.02mm
Lost Motion	0.1mm or less
Base	Material: Aluminum (white alumite treated)
Allowable Static Moment	Ma: 6.9N·m Mb: 9.9N·m Mc: 17.0N·m
Allowable Dynamic Moment (*)	Ma: 2.7N·m Mb: 3.9N·m Mc: 6.8N·m
Overhang Length	Ma direction: 120mm or less; Mb-Mc direction: 120mm or less
Grease Type	Low dust generation grease (both ball screw and guide)
Cleanliness	Class 10 (0.1µm)
Ambient Operating Temp./Humidity	0~40°C, 85% RH or less (non-condensing)

(*) Based on a 5,000km service life.

Directions of Allowable Load Moments

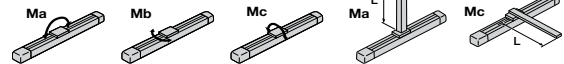

425

RCS2CR-SA4C

Dimensions

For Special Orders P. A-9

- *1 The motor-encoder cable is connected here. See page A-39 for details on cables.
- *2 When homing, the slider moves to the ME; therefore, please watch for any interference with the surrounding objects.
ME: Mechanical end SE: Stroke end
- *3 Reference position for calculating the moment Ma.
- *4 If the actuator is secured using only the mounting holes provided on the top surface of the base, the base may twist to cause abnormal sliding of the slider, or may produce abnormal noise. Therefore, when using the mounting holes on the top surface of the base, keep the stroke at 200mm or less.

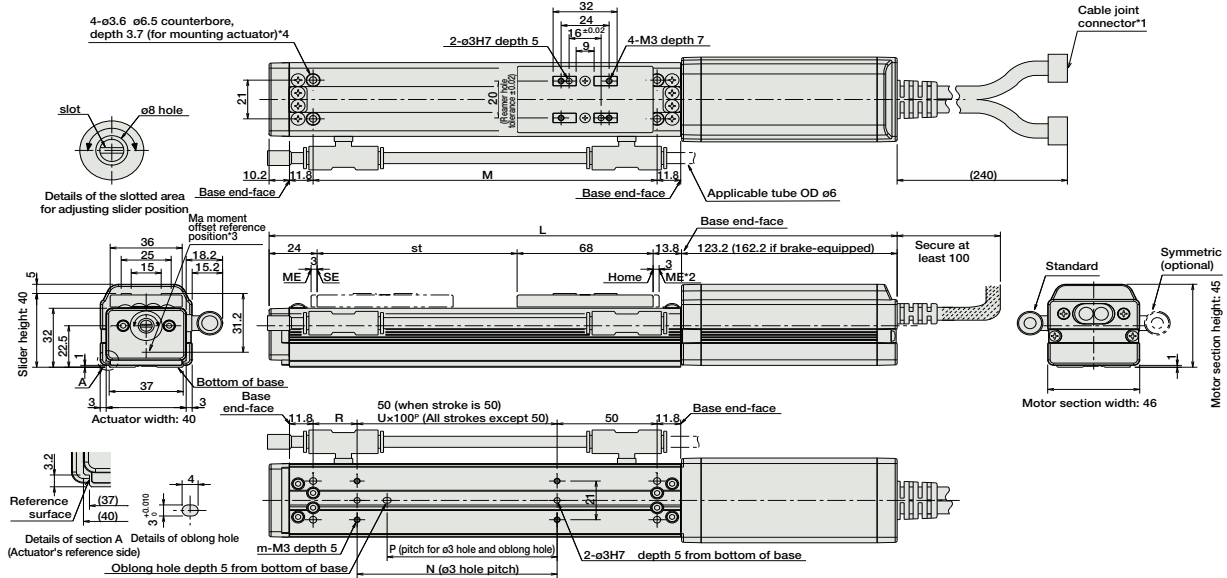

■ Dimensions and Weight by Stroke * Adding a brake will increase the actuator's weight by 0.3kg.

Stroke	50	100	150	200	250	300	350	400	
L	No Brake	279	329	379	429	479	529	579	629
	With Brake	318	368	418	468	518	568	618	668
M	122	172	222	272	322	372	422	472	
N	50	100	100	200	200	300	300	400	
P	35	85	85	185	185	285	285	385	
R	22	22	72	22	72	22	72	22	
U	-	1	1	2	2	3	3	4	
m	4	4	4	6	6	8	8	10	
Weight (kg)	0.7	0.8	0.9	1	1.1	1.2	1.3	1.4	

③ Compatible Controllers

The RCS2CR series actuators can operate with the controllers below. Select the controller according to your usage.

Name	External View	Model	Description	Max. Positioning Points	Input Voltage	Power Supply Capacity	Standard Price	See Page
Positioner Mode		SCON-C-20①-NP-2-②	Positioning is possible for up to 512 points	512 points	Single-phase AC100V Single-phase AC200V Three-phase AC200V (XSEL-P/Q only)	360VA max. * When operating a 150W single-axis model	-	→ P547
Solenoid Valve Mode			Operable with the same controls as the solenoid valve	7 points				
Serial Communication Type			Dedicated to serial communication	64 points				
Pulse Train Input Control Type			Dedicated to pulse train input	(-)				
Program Control 1-2 Axes Type		SSEL-C-1-20①-NP-2-②	Programmed operation is possible Operation is possible on up to 2 axes	20000 points			-	→ P577
Program Control 1-6 Axes Type		XSEL-③-1-20②-N1-EEE-2-④	Programmed operation is possible Operation is possible on up to 6 axes	20000 points			-	→ P587

- * For SSEL and XSEL, only applicable to the single-axis model.
- * ① is a placeholder for the encoder type (I: incremental / A: absolute).
- * ② is a placeholder for the power supply voltage (1: 100V, or 2: single-phase 200V).
- * ③ is a placeholder for the XSEL type name ("J", "K", "P", or "Q").
- * ④ is a placeholder for the power supply voltage (1: 100V, 2: single-phase 200V, 3: 3-phase 200V).

- Slider Type
- Mini
- Standard
- Controllers Integrated
- Rod Type
- Mini
- Standard
- Controllers Integrated
- Table/Arm /Flat Type
- Mini
- Standard
- Gripper/ Rotary Type
- Linear Servo Type
- Cleanroom Type
- Splash-Proof
- Controllers
- PMEC /AMEC
- PSEP /ASEP
- ROBO NET
- ERC2
- PCON
- ACON
- SCON
- PSEL
- ASEL
- SSEL
- XSEL
- Pulse Motor
- Servo Motor (24V)
- Servo Motor (200V)
- Linear Servo Motor

Dimensions

For Special Orders P. A-9

- *1 The motor-encoder cable is connected here. See page A-39 for details on cables.
- *2 After homing, the slider moves to the ME; therefore, please watch for any interference with the surrounding objects.
ME: Mechanical end SE: Stroke end
- *3 Reference position for calculating the moment Ma.
- *4 If the actuator is secured using only the mounting holes provided on the top surface of the base, the base may twist to cause abnormal sliding of the slider, or may produce abnormal noise. Therefore, when using the mounting holes on the top surface of the base, keep the stroke at 300mm or less.

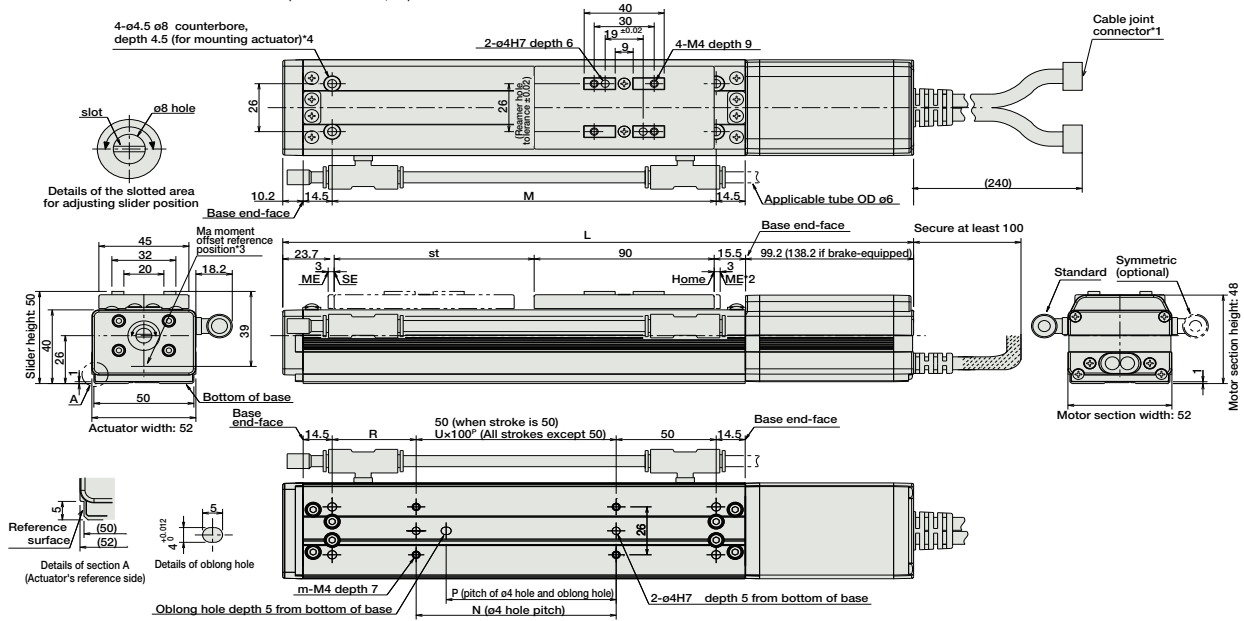

■ Dimensions and Weight by Stroke * Adding a brake will increase the actuator's weight by 0.3kg.

Stroke	50	100	150	200	250	300	350	400	450	500	
L	No Brake	280.4	330.4	380.4	430.4	480.4	530.4	580.4	630.4	680.4	730.4
	With Brake	319.4	369.4	419.4	469.4	519.4	569.4	619.4	669.4	719.4	769.4
M	142	192	242	292	342	392	442	492	542	592	
N	50	100	100	200	200	300	300	400	400	500	
P	35	85	85	185	185	285	285	385	385	485	
R	42	42	92	92	42	42	92	42	92	42	
U	-	1	1	2	2	3	3	4	4	5	
m	4	4	4	6	6	8	8	10	10	12	
Weight (kg)	1.3	1.4	1.5	1.6	1.7	1.8	1.9	2	2.1	2.2	

③ Compatible Controllers

The RCS2CR series actuators can operate with the controllers below. Select the controller according to your usage.

Name	External View	Model	Description	Max. Positioning Points	Input Voltage	Power Supply Capacity	Standard Price	See Page
Positioner Mode		SCON-C-20①-NP-2-②	Positioning is possible for up to 512 points	512 points	Single-phase AC100V Single-phase AC200V Three-phase AC200V (XSEL-P/Q only)	360VA max. * When operating a 150W single-axis model	-	→ P547
Solenoid Valve Mode			Operable with the same controls as the solenoid valve	7 points				
Serial Communication Type			Dedicated to serial communication	64 points				
Pulse Train Input Control Type			Dedicated to pulse train input	(-)				
Program Control 1-2 Axes Type		SSEL-C-1-20①-NP-2-②	Programmed operation is possible Operation is possible on up to 2 axes	20000 points			-	→ P577
Program Control 1-6 Axes Type		XSEL-③-1-20①-N1-EEE-2-④	Programmed operation is possible Operation is possible on up to 6 axes	20000 points			-	→ P587

* For SSEL and XSEL, only applicable to the single-axis model.
 * ① is a placeholder for the encoder type (I: incremental / A: absolute).
 * ② is a placeholder for the power supply voltage (1: 100V, or 2: single-phase 200V).
 * ③ is a placeholder for the XSEL type name ("J", "K", "P", or "Q").
 * ④ is a placeholder for the power supply voltage (1: 100V, 2: single-phase 200V, 3: 3-phase 200V).

- Slider Type
- Mini
- Standard
- Controllers Integrated
- Rod Type
- Mini
- Standard
- Controllers Integrated
- Table/Arm /Flat Type
- Mini
- Standard
- Gripper/ Rotary Type
- Linear Servo Type
- Cleanroom Type
- Splash-Proof
- Controllers
- PMEC /AMEC
- PSEP /ASEP
- ROBO NET
- ERC2
- PCON
- ACON
- SCON
- PSEL
- ASEL
- SSEL
- XSEL
- Pulse Motor
- Servo Motor (24V)
- Servo Motor (200V)
- Linear Servo Motor

RCS2CR-SA6C

Cleanroom ROBO Cylinder Slider Coupling Type 58mm Width 200V Servo Motor Aluminum Base

■ Configuration: **RCS2CR** - **SA6C** - - **30** - - - - -

Series - Type - Encoder - Motor - Lead - Stroke - Compatible Controllers - Cable Length - Option

I : Incremental
A : Absolute

30 : 30W servo motor

12: 12mm
6 : 6mm
3 : 3mm

50: 50mm
600: 600mm (50mm pitch increments)

T1: XSEL-J/K
T2: SCON
SSEL
XSEL-P/Q

N : None
P : 1m
S : 3m
M : 5m
X : Custom
R : Robot cable

See Options below

* See page Pre-35 for an explanation of the naming convention.

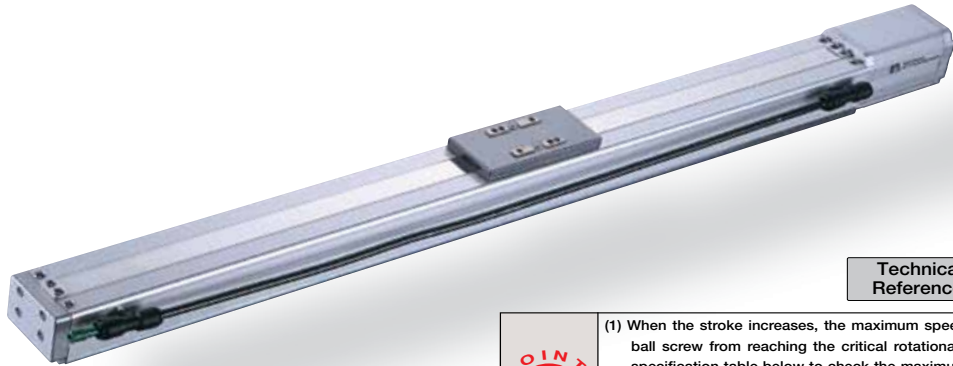

Technical References P. A-5

- POINT**
Notes on Selection
- (1) When the stroke increases, the maximum speed will drop to prevent the ball screw from reaching the critical rotational speed. Use the actuator specification table below to check the maximum speed at the stroke you desire.
 - (2) The load capacity is based on operation at an acceleration of 0.3G (0.2G for the 3mm-lead model). This is the upper limit of the acceleration.

Actuator Specifications

Lead and Load Capacity

Model	Motor Output (W)	Lead (mm)	Max. Load Capacity		Rated Thrust (N)	Stroke (mm)
			Horizontal (kg)	Vertical (kg)		
RCS2CR-SA6C-①-30-12-②-③-④-⑤	30	12	6	1.5	24.2	50~600 (50mm increments)
RCS2CR-SA6C-①-30-6-②-③-④-⑤		6	12	3	48.4	
RCS2CR-SA6C-①-30-3-②-③-④-⑤		3	18	6	96.8	

Legend: ① Encoder ② Stroke ③ Compatible controller ④ Cable length ⑤ Options

Stroke, Max. Speed/Suction Volume

Stroke/Lead	50~450 (50mm increments)				Suction Volume (Nl/min)
	500 (mm)	550 (mm)	600 (mm)	600 (mm)	
12	800	760	640	540	50
6	400	380	320	270	30
3	200	190	160	135	15

(Unit: mm/s)

① Encoder & Stroke List

Stroke (mm)	Standard Price	
	Encoder Type	
	Incremental	Absolute
50	-	-
100	-	-
150	-	-
200	-	-
250	-	-
300	-	-
350	-	-
400	-	-
450	-	-
500	-	-
550	-	-
600	-	-

⑤ Option List

Name	Option Code	See Page	Standard Price
Brake	B	→ A-25	-
Foot bracket	FT	→ A-29	-
Home sensor	HS	→ A-32	-
Reversed-home	NM	→ A-33	-
Intake port mounted on opposite side	VR	→ A-38	-

④ Cable List

Type	Cable Symbol	Standard Price
Standard Type	P (1m)	-
	S (3m)	-
	M (5m)	-
Special Lengths	X06 (6m) ~ X10 (10m)	-
	X11 (11m) ~ X15 (15m)	-
	X16 (16m) ~ X20 (20m)	-
	R01 (1m) ~ R03 (3m)	-
Robot Cable	R04 (4m) ~ R05 (5m)	-
	R06 (6m) ~ R10 (10m)	-
	R11 (11m) ~ R15 (15m)	-
	R16 (16m) ~ R20 (20m)	-

* See page A-39 for cables for maintenance.

Actuator Specifications

Item	Description
Drive System	Ball screw ϕ 10mm C10 grade
Positioning Repeatability	\pm 0.02mm
Lost Motion	0.1mm or less
Base	Material: Aluminum (white alumite treated)
Allowable Static Moment	Ma: 38.3N-m Mb: 54.7N-m Mc: 81.0N-m
Allowable Dynamic Moment (*)	Ma: 8.9N-m Mb: 12.7N-m Mc: 18.6N-m
Overhang Length	Ma direction: 220mm or less; Mb, Mc directions: 220mm or less
Grease type	Low dust generation grease (both ball screw and guide)
Cleanliness	Class 10 (0.1 μ m)
Ambient Operating Temp./Humidity	0~40°C, 85% RH or less (non-condensing)

(*) Based on a 5,000km service life.

Directions of Allowable Load Moments

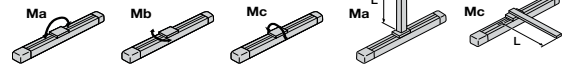

Overhang Load Length

429

RCS2CR-SA6C

Dimensions

For Special Orders P. A-9

- *1 The motor-encoder cable is connected here. See page A-39 for details on cables.
- *2 After homing, the slider moves to the ME; therefore, please watch for any interference with the surrounding objects.
ME: Mechanical end SE: Stroke end
- *3 Reference position for calculating the moment Ma.

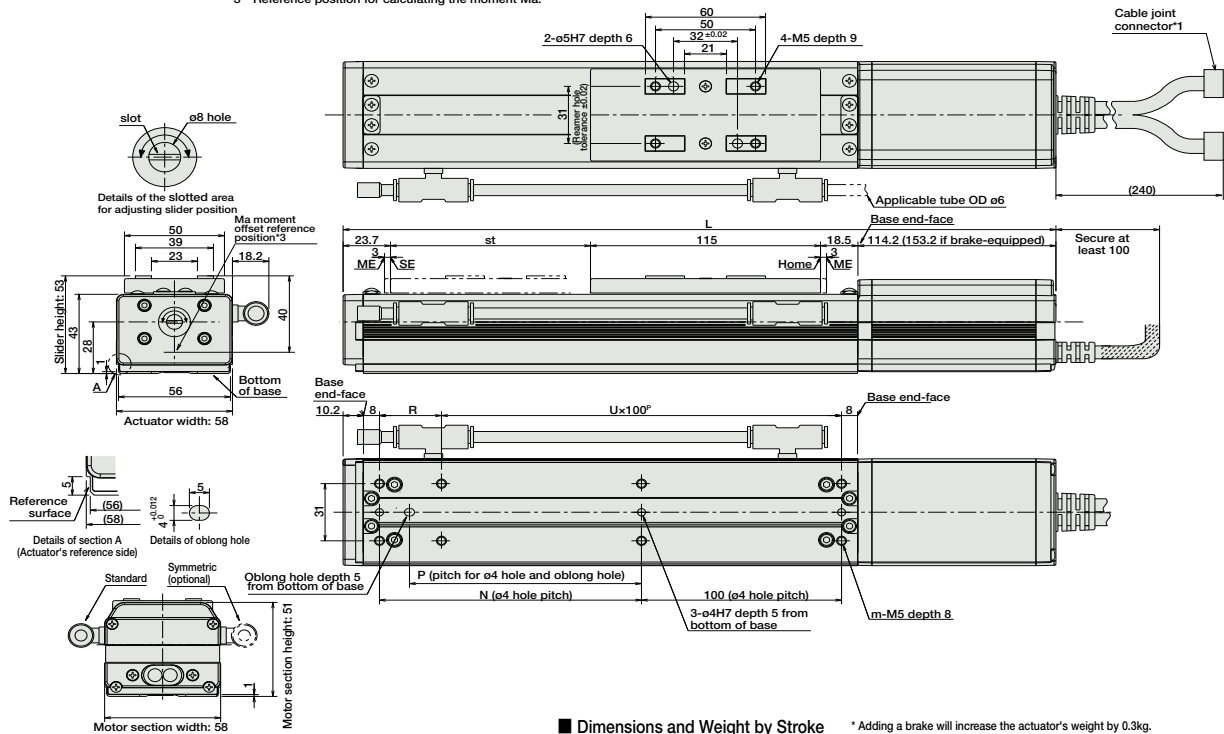

■ Dimensions and Weight by Stroke

* Adding a brake will increase the actuator's weight by 0.3kg.

Stroke	50	100	150	200	250	300	350	400	450	500	550	600
L No Brake	321.4	371.4	421.4	471.4	521.4	571.4	621.4	671.4	721.4	771.4	821.4	871.4
L With Brake	360.4	410.4	460.4	510.4	560.4	610.4	660.4	710.4	760.4	810.4	860.4	910.4
N	81	131	181	231	281	331	381	431	481	531	581	631
P	66	116	166	216	266	316	366	416	466	516	566	616
R	81	31	81	31	81	31	81	31	81	31	81	31
U	1	2	2	3	3	4	4	5	5	6	6	7
m	6	8	8	10	10	12	12	14	14	16	16	18
Weight (kg)	1.4	1.6	1.8	2	2.2	2.4	2.6	2.8	3	3.2	3.4	3.6

③ Compatible Controllers

The RCS2CR series actuators can operate with the controllers below. Select the controller according to your usage.

Name	External View	Model	Description	Max. Positioning Points	Input Voltage	Power Supply Capacity	Standard Price	See Page
Positioner Mode		SCON-C-30D①-NP-2-②	Positioning is possible for up to 512 points	512 points	Single-phase AC100V Single-phase AC200V Three-phase AC200V (XSEL-P/Q only)	360VA max. * When operating a 150W single-axis model	-	→ P547
Solenoid Valve Mode			Operable with the same controls as the solenoid valve	7 points				
Serial Communication Type			Dedicated to serial communication	64 points				
Pulse Train Input Control Type			Dedicated to pulse train input	(-)				
Program Control 1-2 Axes Type		SSEL-C-1-30D①-NP-2-②	Programmed operation is possible Operation is possible on up to 2 axes	20000 points			-	→ P577
Program Control 1-6 Axes Type		XSEL-③-1-30D①-N1-EEE-2-④	Programmed operation is possible Operation is possible on up to 6 axes	20000 points			-	→ P587

- * For SSEL and XSEL, only applicable to the single-axis model.
- * ① is a placeholder for the encoder type (I: incremental / A: absolute).
- * ② is a placeholder for the power supply voltage (1: 100V, or 2: single-phase 200V).
- * ③ is a placeholder for the XSEL type name ("J", "K", "P", or "Q").
- * ④ is a placeholder for the power supply voltage (1: 100V, 2: single-phase 200V, 3: 3-phase 200V).

- Slider Type
- Mini
- Standard
- Controllers Integrated
- Rod Type
- Mini
- Standard
- Controllers Integrated
- Table/Arm /Flat Type
- Mini
- Standard
- Gripper/ Rotary Type
- Linear Servo Type
- Cleanroom Type
- Splash-Proof
- Controllers
- PMEC /AMEC
- PSEP /ASEP
- ROBO NET
- ERC2
- PCON
- ACON
- SCON
- PSEL
- ASEL
- SSEL
- XSEL
- Pulse Motor
- Servo Motor (24V)
- Servo Motor (200V)
- Linear Servo Motor

Dimensions

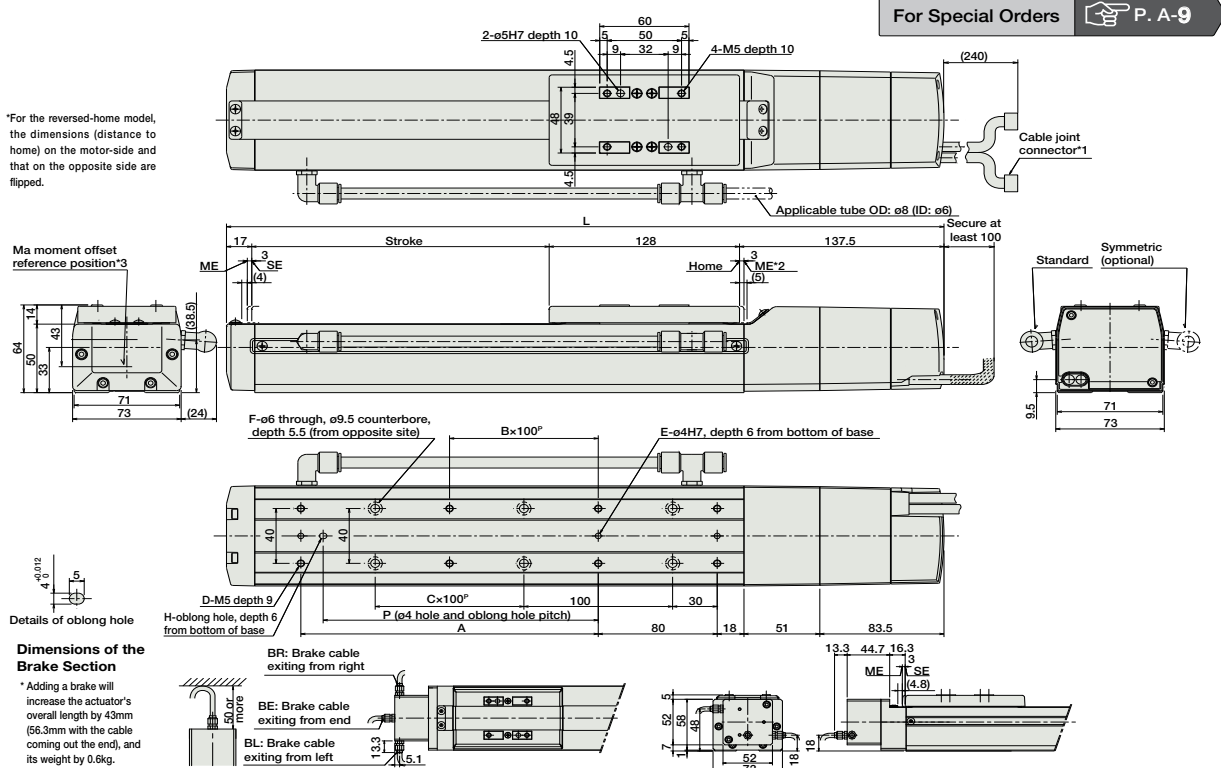

*For the reversed-home model, the dimensions (distance to home) on the motor-side and that on the opposite side are flipped.

For Special Orders P. A-9

Dimensions of the Brake Section

* Adding a brake will increase the actuator's overall length by 43mm (56.3mm with the cable coming out the end), and its weight by 0.6kg.

Dimensions and Weight by Stroke

Stroke	50	100	150	200	250	300	350	400	450	500	550	600	650	700	750	800
L	332.5	382.5	432.5	482.5	532.5	582.5	632.5	682.5	732.5	782.5	832.5	882.5	932.5	982.5	1032.5	1082.5
A	0	100	100	200	200	300	300	400	400	500	500	600	600	700	700	800
B	0	0	0	1	1	2	2	3	3	4	4	5	5	6	6	7
C	0	0	1	1	2	2	3	3	4	4	5	5	6	6	7	7
D	4	6	6	8	8	10	10	12	12	14	14	16	16	18	18	20
E	2	3	3	3	3	3	3	3	3	3	3	3	3	3	3	3
F	4	4	6	6	8	8	10	10	12	12	14	14	16	16	18	18
H	0	1	1	1	1	1	1	1	1	1	1	1	1	1	1	1
P	0	85	85	185	185	285	285	385	385	485	485	585	585	685	685	785
Weight (kg)	2.6	2.8	3.0	3.2	3.5	3.7	3.9	4.1	4.4	4.6	4.8	5.0	5.3	5.5	5.7	5.9

- The motor-encoder cable is connected here. See page A-39 for details on cables.
- When homing, the slider moves to the ME; therefore, please watch for any interference with the surrounding objects.
ME: Mechanical end
SE: Stroke end
The values enclosed in "()" are reference dimensions.
- Reference position for calculating the moment Ma.

Compatible Controllers

The RCS2CR series actuators can operate with the controllers below. Select the controller according to your usage.

Name	External View	Model	Description	Max. Positioning Points	Input Voltage	Power Supply Capacity	Standard Price	See Page
Positioner Mode		SCON-C-60①-NP-2-②	Positioning is possible for up to 512 points	512 points	Single-phase AC100V Single-phase AC200V Three-phase AC200V (XSEL-P/Q only)	360VA max. * When operating a 150W single-axis model	-	→ P547
Solenoid Valve Mode			Operable with the same controls as the solenoid valve	7 points				
Serial Communication Type			Dedicated to serial communication	64 points				
Pulse Train Input Control Type			Dedicated to pulse train input	(-)				
Program Control 1-2 Axes Type		SSEL-C-1-60①-NP-2-②	Programmed operation is possible Operation is possible on up to 2 axes	20000 points			-	→ P577
Program Control 1-6 Axes Type		XSEL-③-1-60①-N1-EEE-2-④	Programmed operation is possible Operation is possible on up to 6 axes	20000 points			-	→ P587

- * For SSEL and XSEL, only applicable to the single-axis model.
- * ① is a placeholder for the encoder type (I: incremental / A: absolute).
- * ② is a placeholder for the power supply voltage (1: 100V, or 2: single-phase 200V).
- * ③ is a placeholder for the XSEL type name ("J", "K", "P", or "Q").
- * ④ is a placeholder for the power supply voltage (1: 100V, 2: single-phase 200V, 3: 3-phase 200V).

- Slider Type
- Mini
- Standard
- Controllers Integrated
- Rod Type
- Mini
- Standard
- Controllers Integrated
- Table/Arm /Flat Type
- Mini
- Standard
- Gripper/ Rotary Type
- Linear Servo Type
- Cleanroom Type
- Splash-Proof
- Controllers
- PMEC /AMEC
- PSEP /ASEP
- ROBO NET
- ERC2
- PCON
- ACON
- SCON
- PSEL
- ASEL
- SSEL
- XSEL
- Pulse Motor
- Servo Motor (24V)
- Servo Motor (200V)
- Linear Servo Motor

Dimensions

For Special Orders P. A-9

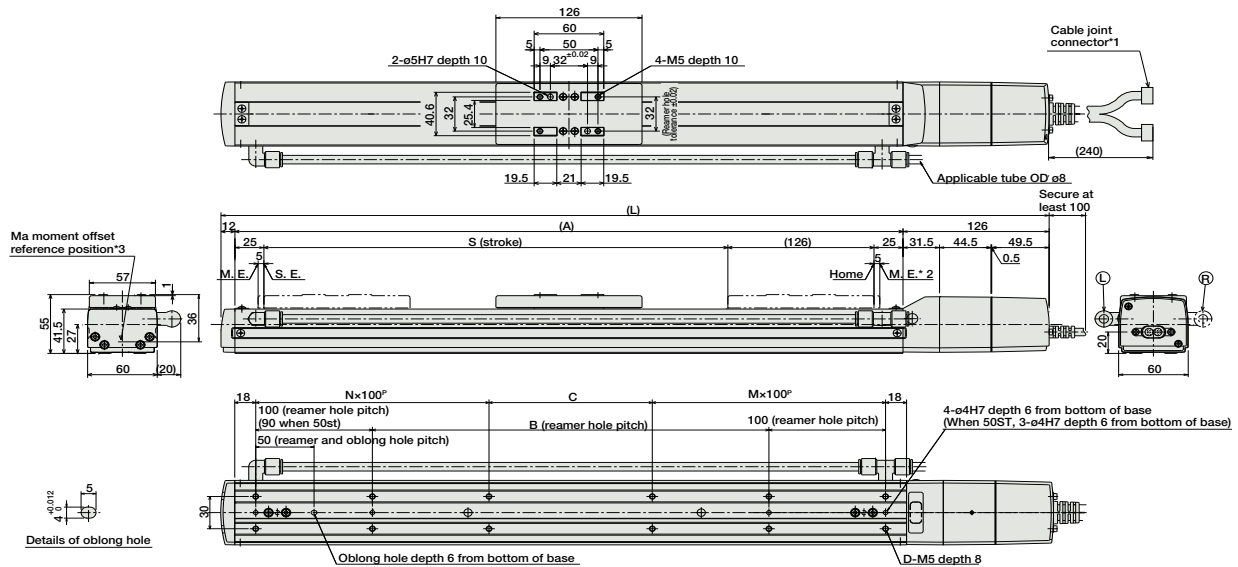

Dimensions of the Brake Section

*The length L of a brake-equipped actuator is longer than that of a standard model by 24.5mm; add 0.3kg to weight.

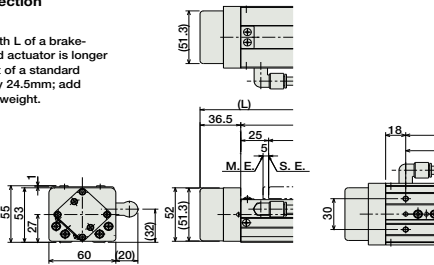

- The motor-encoder cable is connected here. See page A-39 for details on cables.
- When homing, the slider moves to the ME; therefore, please watch for any interference with the surrounding objects.
ME: Mechanical end
SE: Stroke end
The values enclosed in "()" are reference dimensions.
- Reference position for calculating the moment Ma.

■ Dimensions and Weight by Stroke

Stroke	50	100	150	200	250	300	350	400	450	500	550	600
L	364	414	464	514	564	614	664	714	764	814	864	914
A	226	276	326	376	426	476	526	576	626	676	726	776
B	0	40	90	140	190	240	290	340	390	440	490	540
C	90	40	90	140	190	40	90	140	190	40	90	140
D	6	8	8	8	8	12	12	12	12	16	16	16
M	1	1	1	1	1	2	2	2	2	3	3	3
N	0	1	1	1	1	2	2	2	2	3	3	3
Weight (kg)	3.1	3.4	3.7	4.0	4.4	4.7	5.0	5.3	5.7	6.0	6.3	6.6

③ Compatible Controllers

The RCS2CR series actuators can operate with the controllers below. Select the controller according to your usage.

Name	External View	Model	Description	Max. Positioning Points	Input Voltage	Power Supply Capacity	Standard Price	See Page
Positioner Mode		SCON-C-60①-NP-2-②	Positioning is possible for up to 512 points	512 points	Single-phase AC100V Single-phase AC200V Three-phase AC200V (XSEL-P/Q only)	360VA max. * When operating a 150W single-axis model	-	→ P547
Solenoid Valve Mode			Operable with the same controls as the solenoid valve	7 points				
Serial Communication Type			Dedicated to serial communication	64 points				
Pulse Train Input Control Type			Dedicated to pulse train input	(-)				
Program Control 1-2 Axes Type		SSEL-C-1-60①-NP-2-④	Programmed operation is possible Operation is possible on up to 2 axes	20000 points			-	→ P577
Program Control 1-6 Axes Type		XSEL-③-1-60①-N1-EEE-2-④	Programmed operation is possible Operation is possible on up to 6 axes	20000 points			-	→ P587

- * For SSEL and XSEL, only applicable to the single-axis model.
- ① is a placeholder for the encoder type (I: incremental / A: absolute).
- ② is a placeholder for the power supply voltage (1: 100V, or 2: single-phase 200V).
- ③ is a placeholder for the XSEL type name ("J", "K", "P", or "Q").
- ④ is a placeholder for the power supply voltage (1: 100V, 2: single-phase 200V, 3: 3-phase 200V).

IAI

RCS2CR-SS7C

434

Sold & Serviced By:

ELECTROMATE

Toll Free Phone (877) SERV098

Toll Free Fax (877) SERV099

www.electromate.com

sales@electromate.com

Slider Type

Mini

Standard

Controllers Integrated

Rod Type

Mini

Standard

Controllers Integrated

Table/Arm /Flat Type

Mini

Standard

Gripper/ Rotary Type

Linear Servo Type

Cleanroom Type

Splash-Proof

Controllers

PMEC /AMEC

PSEP /ASEP

ROBO NET

ERC2

PCON

ACON

SCON

PSEL

ASEL

SSEL

XSEL

Pulse Motor

Servo Motor (24V)

Servo Motor (200V)

Linear Servo Motor

RCS2CR-SS8C

Cleanroom ROBO Cylinder Slider Coupling Type 80mm Width 200V Servo Motor Steel Base

■ Configuration: **RCS2CR-SS8C** — [] — [] — [] — [] — [] — [] — [] — []

Series — Type — Encoder — Motor — Lead — Stroke — Compatible Controllers — Cable Length — Option

I : Incremental
A : Absolute

100 : 100W servo motor
150 : 150W servo motor

20 : 20mm
10 : 10mm

50 : 50mm
1000 : 1000mm (50mm pitch increments)

T1 : XSEL-J/K
T2 : SCON
SSEL
XSEL-P/Q

N : None
P : 1m
S : 3m
M : 5m
X [] : Custom
R [] : Robot cable

See Options below

* See page Pre-35 for an explanation of the naming convention.



Technical References P. A-5

- 4 POINT Notes on Selection**
- (1) When the stroke increases, the maximum speed will drop to prevent the ball screw from reaching the critical rotational speed. Use the actuator specification table below to check the maximum speed at the stroke you desire.
 - (2) The load capacity is based on operation at an acceleration of 0.3G. This is the upper limit of the acceleration.

Actuator Specifications

Lead and Load Capacity

Model	Motor Output (W)	Lead (mm)	Max. Load Capacity		Rated Thrust (N)	Stroke (mm)
			Horizontal (kg)	Vertical (kg)		
RCS2CR-SS8C-①-100-20-②-③-④-⑤	100	20	20	4	84.9	50~1000 (50mm increments)
RCS2CR-SS8C-①-100-10-②-③-④-⑤		10	40	8		
RCS2CR-SS8C-①-150-20-②-③-④-⑤	150	20	30	6	128	
RCS2CR-SS8C-①-150-10-②-③-④-⑤		10	60	12		

Legend: ① Encoder ② Stroke ③ Compatible controller ④ Cable length ⑤ Options

Stroke, Max. Speed/Suction Volume

Stroke/Lead	50~600 (50mm increments)	~700 (mm)	~800 (mm)	~900 (mm)	~1000 (mm)	Suction Volume (Nl/min)
	20	1000	960	765	625	
10	500	480	380	310	255	40

(Unit: mm/s)

① Encoder & Stroke List

Stroke (mm)	Standard Price			
	Encoder Type			
	Incremental		Absolute	
	Motor Output (W)		Motor Output (W)	
	100W	150W	100W	150W
50/100	-	-	-	-
150/200	-	-	-	-
250/300	-	-	-	-
350/400	-	-	-	-
450/500	-	-	-	-
550/600	-	-	-	-
650/700	-	-	-	-
750/800	-	-	-	-
850/900	-	-	-	-
950/1000	-	-	-	-

⑤ Option List

Name	Option Code	See Page	Standard Price
Brake	B	→ A-25	-
Reversed-home	NM	→ A-33	-
Intake port mounted on opposite side	VR	→ A-38	-

④ Cable List

Type	Cable Symbol	Standard Price
Standard Type	P (1m)	-
	S (3m)	-
	M (5m)	-
Special Lengths	X06 (6m) ~ X10 (10m)	-
	X11 (11m) ~ X15 (15m)	-
	X16 (16m) ~ X20 (20m)	-
Robot Cable	R01 (1m) ~ R03 (3m)	-
	R04 (4m) ~ R05 (5m)	-
	R06 (6m) ~ R10 (10m)	-
	R11 (11m) ~ R15 (15m)	-
	R16 (16m) ~ R20 (20m)	-

* See page A-39 for cables for maintenance.

Actuator Specifications

Item	Description
Drive System	Ball screw ø16mm C10 grade
Positioning Repeatability	±0.02mm
Lost Motion	0.1mm or less
Base	Material: Special alloy steel
Allowable Static Moment	Ma: 198.9N·m Mb: 198.9N·m Mc: 416.7N·m
Allowable Dynamic Moment (*)	Ma: 36.3N·m Mb: 36.3N·m Mc: 77.4N·m
Overhang Load Length	Ma direction: 450mm or less Mb-Mc direction: 450mm or less
Grease Type	Low dust generation grease (both ball screw and guide)
Cleanliness	Class 10 (0.1µm)
Ambient Operating Temp./Humidity	0~40°C, 85% RH or less (non-condensing)

(*) Based on a 10,000km service life.

Directions of Allowable Load Moments

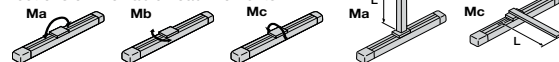

435

RCS2CR-SS8C

Dimensions

For Special Orders P. A-9

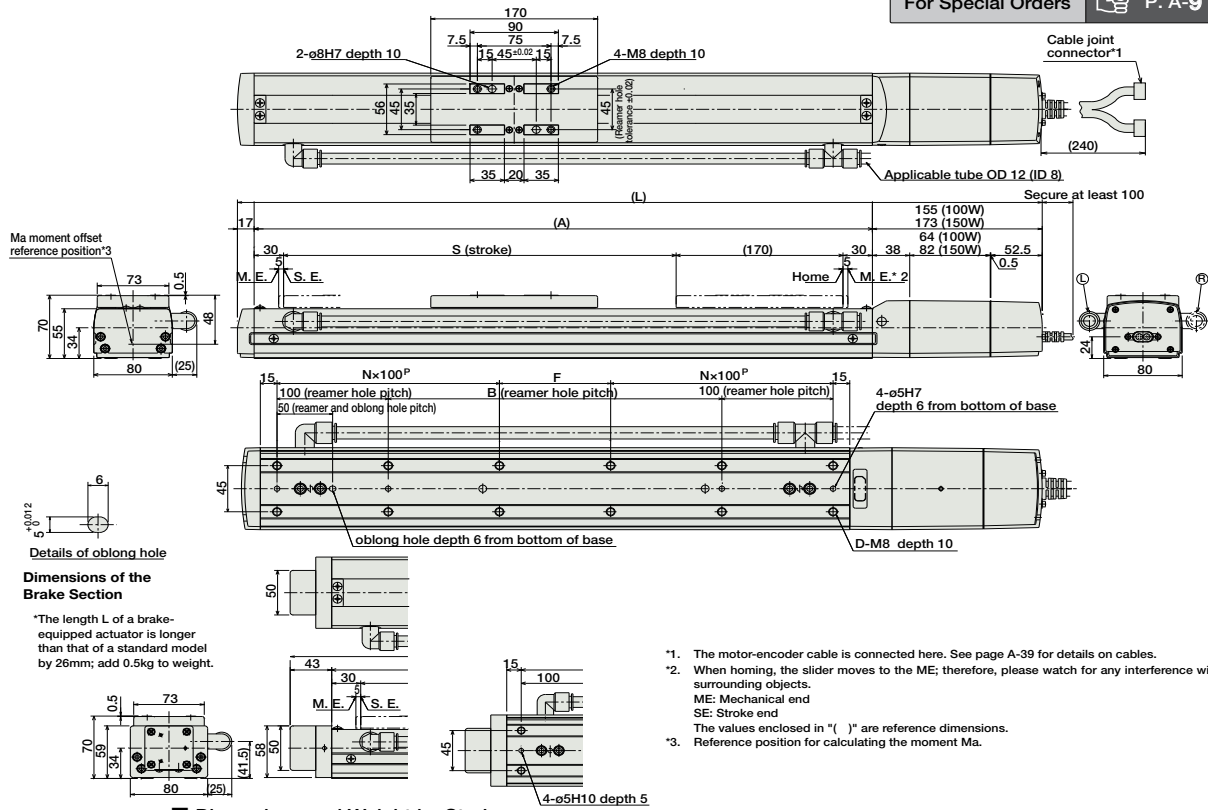

Dimensions of the Brake Section

*The length L of a brake-equipped actuator is longer than that of a standard model by 26mm; add 0.5kg to weight.

- *1. The motor-encoder cable is connected here. See page A-39 for details on cables.
- *2. When homing, the slider moves to the ME; therefore, please watch for any interference with the surrounding objects.
ME: Mechanical end
SE: Stroke end
The values enclosed in "() " are reference dimensions.
- *3. Reference position for calculating the moment Ma.

Dimensions and Weight by Stroke

Stroke	50	100	150	200	250	300	350	400	450	500	550	600	650	700	750	800	850	900	950	1000
L (100W)	452	502	552	602	652	702	752	802	852	902	952	1002	1052	1102	1152	1202	1252	1302	1352	1402
L (150W)	470	520	570	620	670	720	770	820	870	920	970	1020	1070	1120	1170	1220	1270	1320	1370	1420
A	280	330	380	430	480	530	580	630	680	730	780	830	880	930	980	1030	1080	1130	1180	1230
B	50	100	150	200	250	300	350	400	450	500	550	600	650	700	750	800	850	900	950	1000
D	8	8	8	10	12	12	12	14	16	16	18	18	20	20	20	22	24	24	24	26
F	50	100	150	0	50	100	150	0	50	100	150	0	50	100	150	0	50	100	150	0
N	1	1	1	2	2	2	3	3	3	3	3	4	4	4	4	5	5	5	5	6
Weight (kg)	6.5	7.0	7.6	8.1	8.7	9.2	9.8	10.3	10.9	11.4	12.0	12.5	13.1	13.6	14.2	14.7	15.3	15.8	16.4	16.9

③ Compatible Controllers

The RCS2CR series actuators can operate with the controllers below. Select the controller according to your usage.

Name	External View	Model	Description	Max. Positioning Points	Input Voltage	Power Supply Capacity	Standard Price	See Page
Positioner Mode		SCON-C-100①-NP-2-② SCON-C-150①-NP-2-②	Positioning is possible for up to 512 points	512 points	Single-phase AC100V Single-phase AC200V Three-phase AC200V (XSEL-P/Q only)	360VA max. * When operating a 150W single-axis model	-	→ P547
Solenoid Valve Mode			Operable with the same controls as the solenoid valve	7 points				
Serial Communication Type			Dedicated to serial communication	64 points				
Pulse Train Input Control Type			Dedicated to pulse train input	(-)				
Program Control 1-2 Axes Type		SSEL-C-1-100①-NP-2-② SSEL-C-1-150①-NP-2-②	Programmed operation is possible Operation is possible on up to 2 axes	20000 points			-	→ P577
Program Control 1-6 Axes Type		XSEL-③-1-100①-N1-EEE-2-④ XSEL-③-1-150①-N1-EEE-2-④	Programmed operation is possible Operation is possible on up to 6 axes	20000 points			-	→ P587

- * For SSEL and XSEL, only applicable to the single-axis model.
- * ① is a placeholder for the encoder type (I: incremental / A: absolute).
- * ② is a placeholder for the power supply voltage (1: 100V, or 2: single-phase 200V).
- * ③ is a placeholder for the XSEL type name ("J", "K", "P", or "Q").
- * ④ is a placeholder for the power supply voltage (1: 100V, 2: single-phase 200V, 3: 3-phase 200V).

- Slider Type
- Mini
- Standard
- Controllers Integrated
- Rod Type
- Mini
- Standard
- Controllers Integrated
- Table/Arm /Flat Type
- Mini
- Standard
- Gripper/ Rotary Type
- Linear Servo Type
- Cleanroom Type
- Splash-Proof
- Controllers
- PMEC /AMEC
- PSEP /ASEP
- ROBO NET
- ERC2
- PCON
- ACON
- SCON
- PSEL
- ASEL
- SSEL
- XSEL
- Pulse Motor
- Servo Motor (24V)
- Servo Motor (200V)
- Linear Servo Motor

Dimensions

For Special Orders P. A-9

- *1. The motor-encoder cable is connected here. See page A-39 for details on cables.
- *2. When homing, the slider moves to the ME; therefore, please watch for any interference with the surrounding objects.
ME: Mechanical end
SE: Stroke end
The values enclosed in "()" are reference dimensions.
- *3. Reference position for calculating the moment Ma.
- *4. If the actuator is secured using only the mounting holes provided on the top surface of the base, the base may twist to cause abnormal sliding of the slider, or may produce abnormal noise. Therefore, when using the mounting holes on the top surface of the base, keep the stroke at 300mm or less.

* Note that in order to change the home orientation, arrangements must be made to send in the product to IAI.
* In the reversed-home model (NM), the new home position is set 3mm inward from the ME opposite of the motor-side.

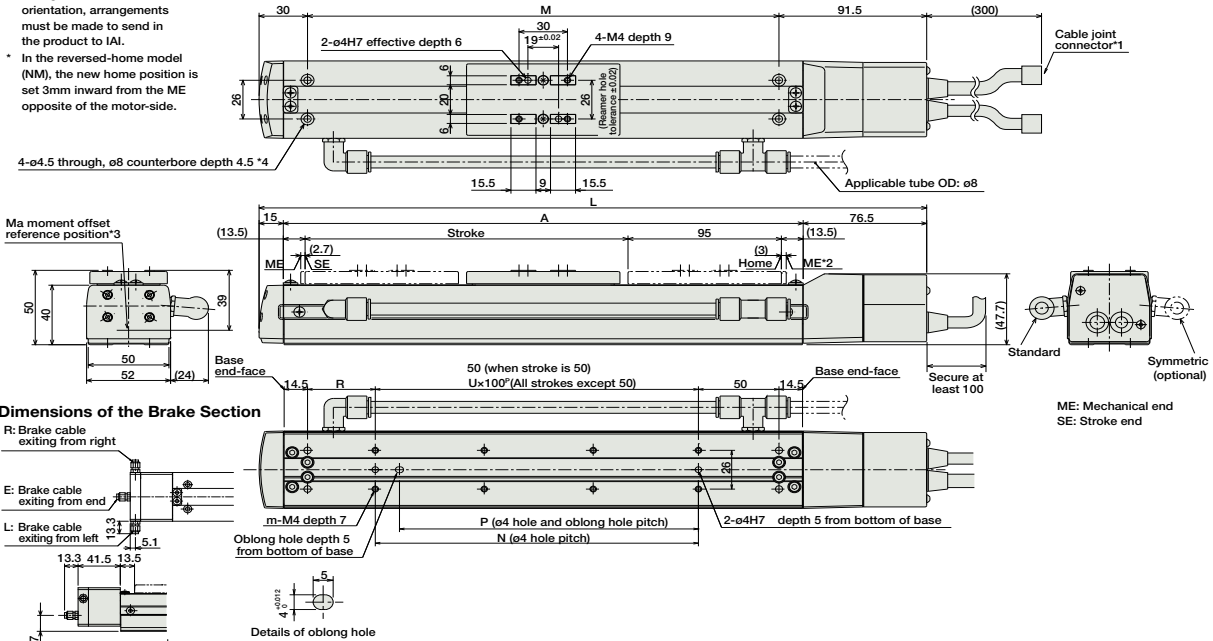

Dimensions of the Brake Section

R: Brake cable exiting from right
E: Brake cable exiting from end
L: Brake cable exiting from left

* Adding a brake will increase the actuator's overall length by 26.5mm (39.8mm with the cable coming out the end), and its weight by 0.3kg.

■ Dimensions and Weight by Stroke

Stroke	50	100	150	200	250	300	350	400	450	500
L	263.5	313.5	363.5	413.5	463.5	513.5	563.5	613.5	663.5	713.5
A	172	222	272	322	372	422	472	522	572	622
M	142	192	242	292	342	392	442	492	542	592
N	50	100	100	200	200	300	300	400	400	500
P	35	85	85	185	185	285	285	385	385	485
R	42	42	42	92	42	92	42	92	42	42
U	-	1	1	2	2	3	3	4	4	5
m	4	4	4	6	6	8	8	10	10	12
Weight (kg)	1.5	1.6	1.7	1.8	1.9	2.0	2.1	2.2	2.3	2.5

③ Compatible Controllers

The RCS2CR series actuators can operate with the controllers below. Select the controller according to your usage.

Name	External View	Model	Description	Max. Positioning Points	Input Voltage	Power Supply Capacity	Standard Price	See Page
Positioner Mode		SCON-C-20①-NP-2-②	Positioning is possible for up to 512 points	512 points	Single-phase AC100V Single-phase AC200V Three-phase AC200V (XSEL-P/Q only)	360VA max. * When operating a 150W single-axis model	-	→ P547
Solenoid Valve Mode			Operable with the same controls as the solenoid valve	7 points				
Serial Communication Type			Dedicated to serial communication	64 points				
Pulse Train Input Control Type			Dedicated to pulse train input	(-)				
Program Control 1-2 Axes Type		SSEL-C-1-20①-NP-2-②	Programmed operation is possible Operation is possible on up to 2 axes	20000 points			-	→ P577
Program Control 1-6 Axes Type		XSEL-③-1-20①-N1-EEE-2-④	Programmed operation is possible Operation is possible on up to 6 axes	20000 points			-	→ P587

- * For SSEL and XSEL, only applicable to the single-axis model.
- * ① is a placeholder for the encoder type (I: incremental / A: absolute).
- * ② is a placeholder for the power supply voltage (1: 100V, or 2: single-phase 200V).
- * ③ is a placeholder for the XSEL type name ("J", "K", "P", or "Q").
- * ④ is a placeholder for the power supply voltage (1: 100V, 2: single-phase 200V, 3: 3-phase 200V).

- Slider Type
- Mini
- Standard
- Controllers Integrated
- Rod Type
- Mini
- Standard
- Controllers Integrated
- Table/Arm /Flat Type
- Mini
- Standard
- Gripper/ Rotary Type
- Linear Servo Type
- Cleanroom Type
- Splash-Proof
- Controllers
- PMEC /AMEC
- PSEP /ASEP
- ROBO NET
- ERC2
- PCON
- ACON
- SCON
- PSEL
- ASEL
- SSEL
- XSEL
- Pulse Motor
- Servo Motor (24V)
- Servo Motor (200V)
- Linear Servo Motor

RCS2CR-SA6D

Cleanroom ROBO Cylinder Slider Built-In Type 58mm Width 200V Servo Motor Aluminum Base

■ Configuration: **RCS2CR-SA6D** — — **30** — — — — —

Series	Type	Encoder	Motor	Lead	Stroke	Compatible Controllers	Cable Length	Option
I : Incremental A : Absolute	30 : 30W servo motor	12:12mm 6 : 6mm 3 : 3mm	50: 50mm 600: 600mm (50mm pitch increments)	T1:XSEL-J/K T2:SCON SSEL XSEL-P/Q	N : None P : 1m S : 3m M : 5m X <input type="checkbox"/> : Custom R <input type="checkbox"/> : Robot cable	See Options below		

* See page Pre-35 for an explanation of the naming convention.

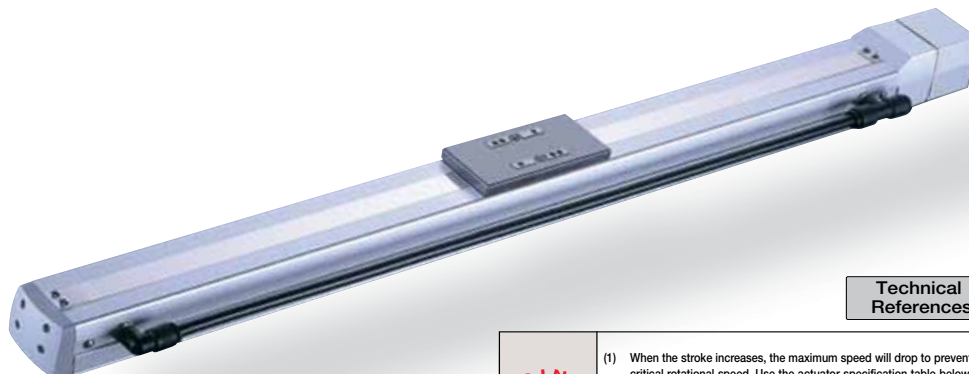

Technical References P. A-5

- POINT**
Notes on Selection
- When the stroke increases, the maximum speed will drop to prevent the ball screw from reaching the critical rotational speed. Use the actuator specification table below to check the maximum speed at the stroke you desire.
 - The load capacity is based on operation at an acceleration of 0.3G (0.2G for the 3mm-lead model). This is the upper limit of the acceleration.
 - The cleanliness class 10 is for horizontal usage. Please note that the actuator may not support C10 when used on its side or in vertical orientation.

Actuator Specifications

Lead and Load Capacity

Model	Motor Output (W)	Lead (mm)	Max. Load Capacity		Rated Thrust (N)	Stroke (mm)
			Horizontal (kg)	Vertical (kg)		
RCS2CR-SA6D-①-30-12-②-③-④-⑤	30	12	6	1.5	24.2	50~600 (50mm increments)
RCS2CR-SA6D-①-30-6-②-③-④-⑤		6	12	3	48.4	
RCS2CR-SA6D-①-30-3-②-③-④-⑤		3	18	6	96.8	

Legend: ① Encoder ② Stroke ③ Compatible controller ④ Cable length ⑤ Options

Stroke, Max. Speed/Suction Volume

Stroke/Lead	50~450 (50mm increments)	500 (mm)	650 (mm)	600 (mm)	Suction Volume (N/min)
12	800	760	640	540	50
6	400	380	320	270	30
3	200	190	160	135	15

(Unit: mm/s)

① Encoder & Stroke List

Stroke (mm)	Standard Price	
	Encoder Type	
	Incremental	Absolute
50	-	-
100	-	-
150	-	-
200	-	-
250	-	-
300	-	-
350	-	-
400	-	-
450	-	-
500	-	-
550	-	-
600	-	-

⑤ Option List

Name	Option Code	See Page	Standard Price
Brake (Cable exiting from end)	BE	→ A-25	-
Brake (Cable exiting from left)	BL	→ A-25	-
Brake (Cable exiting from right)	BR	→ A-25	-
Reversed-home	NM	→ A-33	-
Intake port mounted on opposite side	VR	→ A-38	-

④ Cable List

Type	Cable Symbol	Standard Price
Standard Type	P (1m)	-
	S (3m)	-
	M (5m)	-
Special Lengths	X06 (6m) ~ X10 (10m)	-
	X11 (11m) ~ X15 (15m)	-
	X16 (16m) ~ X20 (20m)	-
Robot Cable	R01 (1m) ~ R03 (3m)	-
	R04 (4m) ~ R05 (5m)	-
	R06 (6m) ~ R10 (10m)	-
	R11 (11m) ~ R15 (15m)	-
	R16 (16m) ~ R20 (20m)	-

* See page A-39 for cables for maintenance.

Actuator Specifications

Item	Description
Drive System	Ball screw ø10mm C10 grade
Positioning Repeatability	±0.02mm
Lost Motion	0.1mm or less
Base	Material: Aluminum (white alumite treated)
Allowable Static Moment	Ma: 38.3N·m Mb: 54.7N·m Mc: 81.0N·m
Allowable Dynamic Moment (τ)	Ma: 8.9N·m Mb: 12.7N·m Mc: 18.6N·m
Overhang Length	Ma direction: 220mm or less; Mb, Mc directions: 220mm or less
Grease Type	Low dust generation grease (both ball screw and guide)
Cleanliness	Class 10 (0.1μm)
Ambient Operating Temp./Humidity	0~40°C, 85% RH or less (non-condensing)

(*) Based on a 5,000km service life.

Directions of Allowable Load Moments



Overhang Load Length

439

RCS2CR-SA6D

Dimensions

For Special Orders P. A-9

* Note that in order to change the home orientation, arrangements must be made to send in the product to IAI.
 * In the reversed-home model (NM), the new home position is set 3mm inward from the ME opposite of the motor-side.

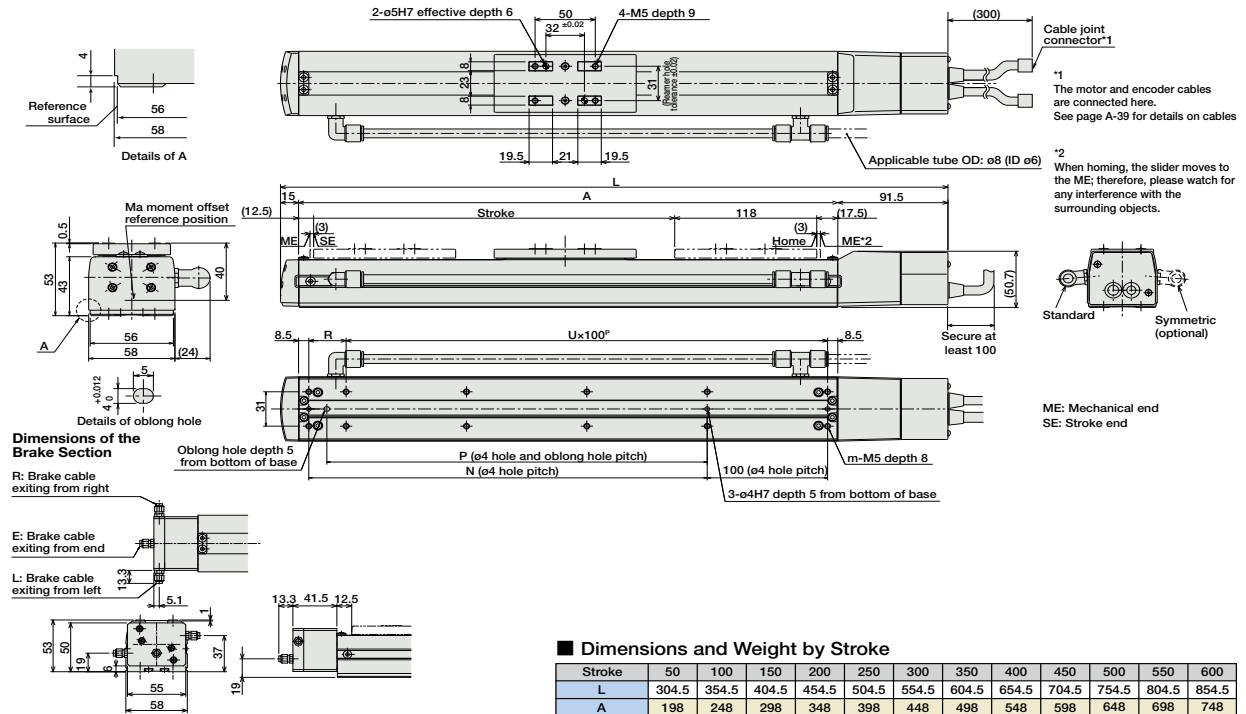

■ Dimensions and Weight by Stroke

Stroke	50	100	150	200	250	300	350	400	450	500	550	600
L	304.5	354.5	404.5	454.5	504.5	554.5	604.5	654.5	704.5	754.5	804.5	854.5
A	198	248	298	348	398	448	498	548	598	648	698	748
N	81	131	181	231	281	331	381	431	481	531	581	631
P	66	116	166	216	266	316	366	416	466	516	566	616
R	81	31	81	31	81	31	81	31	81	31	81	31
U	1	2	2	3	3	4	4	5	5	6	6	7
m	6	8	8	10	10	12	12	14	14	16	16	18
Weight (kg)	2.0	2.1	2.3	2.4	2.6	2.7	2.9	3.0	3.2	3.3	3.5	3.6

* Adding a brake will increase the actuator's overall length by 26.5mm (39.8mm with the cable coming out the end), and its weight by 0.3kg.

③ Compatible Controllers

The RCS2CR series actuators can operate with the controllers below. Select the controller according to your usage.

Name	External View	Model	Description	Max. Positioning Points	Input Voltage	Power Supply Capacity	Standard Price	See Page
Positioner Mode		SCON-C-30D ①-NP-2-②	Positioning is possible for up to 512 points	512 points	Single-phase AC100V Single-phase AC200V Three-phase AC200V (XSEL-P/Q only)	360VA max. * When operating a 150W single-axis model	-	→ P547
Solenoid Valve Mode			Operable with the same controls as the solenoid valve	7 points				
Serial Communication Type			Dedicated to serial communication	64 points				
Pulse Train Input Control Type			Dedicated to pulse train input	(-)				
Program Control 1-2 Axes Type		SSEL-C-1-30D ①-NP-2-②	Programmed operation is possible Operation is possible on up to 2 axes	20000 points			-	→ P577
Program Control 1-6 Axes Type		XSEL-③-1-30D ①-N1-EEE-2-④	Programmed operation is possible Operation is possible on up to 6 axes	20000 points			-	→ P587

* For SSEL and XSEL, only applicable to the single-axis model.
 * ① is a placeholder for the encoder type (I: incremental / A: absolute).
 * ② is a placeholder for the power supply voltage (1: 100V, or 2: single-phase 200V).
 * ③ is a placeholder for the XSEL type name ("J", "K", "P", or "Q").
 * ④ is a placeholder for the power supply voltage (1: 100V, 2: single-phase 200V, 3: 3-phase 200V).

- Slider Type
- Mini
- Standard
- Controllers Integrated
- Rod Type
- Mini
- Standard
- Controllers Integrated
- Table/Arm /Flat Type
- Mini
- Standard
- Gripper/ Rotary Type
- Linear Servo Type
- Cleanroom Type
- Splash-Proof
- Controllers
- PMEC /AMEC
- PSEP /ASEP
- ROBO NET
- ERC2
- PCON
- ACON
- SCON
- PSEL
- ASEL
- SSEL
- XSEL
- Pulse Motor
- Servo Motor (24V)
- Servo Motor (200V)
- Linear Servo Motor